

CATÁLOGO TARIFA



2024



J2, VOCACIÓN POR EL BUEN HACER

1980, nace J2 importaciones y distribuciones una empresa con carácter familiar que originalmente se centra en la fabricación y distribución de carteles y bandejas para la industria alimentaria y el sector hostelero. Rápidamente son añadidos nuevos productos como: tacos y pilones, polietileno, picadoras, máquinas de vacío, retractiladoras, cuchillos, ganchos, hamburgueseras, exterminadores de insectos, cubetas gastronorm, taquillas, indicadores "su turno"... todo ello fruto de la gran demanda e inquietud por poder ofrecer a nuestros distribuidores todo lo que necesiten. Actualmente J2 es una empresa consolidada y reconocida en la industria alimentaria y el sector hostelero, con más de 2500 referencias que se pueden encontrar en nuestro catálogo. J2 plantea el futuro con ilusiones renovadas. Un equipo joven y dinámico afronta los nuevos retos y oportunidades que genera la globalización. Nuestra inquietud por innovar nos lleva a visitar y exponer en las principales ferias del sector en Europa, para conocer los avances del sector. Nuestra amplia experiencia en importación y distribución nos permite garantizar un producto actual, de calidad y duradero para nuestros distribuidores.





**Reservamos el derecho a modificar ó alterar nuestros productos sin previo aviso.
Los precios son válidos salvo error tipográfico o de impresión.**

ÍNDICE

1

Complementos
Tajos
Tacos de madera
Pilonos
Polietileno
Mesas de madera
Mesas acero-inox
Artículos polietileno
Palas polietileno
Soporte tablas polietileno

2

Carteles portaprecios
Soportes carteles
Carteles señalización
Guirnaldas
Separadores
Decoración
Barreños industriales
Cubetas
Base rodante
Bandejas
Gastronorm
PlexiLine

3

Picadoras
Empujadores picadoras
Cuchillas y placas picadoras
Cintas de sierra
Cortadoras
Ralladoras
Exprimidor cítricos
Cortadora multifunción
Cutters
Molino
Afiladoras

4 - 23

24 - 63

64 - 83

4

Máquinas retractilar
Film
Dispensadores de film
Dispensador papel aluminio
Soldadoras de bolsas
Máquina vacío
Bolsas vacío
Parrilla y palas envasadoras
Termoselladoras

5

Secamanos
Dispensador papel celulosa
Papel celulosa
Dosificadores de jabón
Grifos
Lavamanos
Grifos ducha
Portacuchillos
Papeleras
Cañón de ozono
Esterilizadores de cuchillos
Contenedores plástico
Contenedores papeleras acero-inoxidable

6

Indicadores de turno
Reloj-temperatura
Expendedores de tickets
Rollo tickets
Exterminadores de insectos
Detector contador billetes - monedas

84 - 95

96 - 115

116 - 129

7

Hamburgueseras
Papel celofán y separador interloncheado
Embutidoras
Sujeta jamones
Jamonero rotatorio 360°
Cono y calas
Ganchos
Libradores
Pinzas
Porta notas
Porta rollo
Soporte para pinchar tickets
Máquina y molde para brochetas
Enternecedor de carne
Mallas y anillas elásticas
Tubos para enmallar rellenos
Protector hueso
Termómetros

8

Cierra bolsas - rollos
Etiquetadoras - rollos
Navteadoras
Carros de servicio
Carros bandejeros - plegables - Gastronorm
Cestos - carros autoservicio
Dispensadores bolsas
Guantes y papeleras

9

Cuchillería profesional
Imanes
Afiladores
Piedras de afilar
Chairas
Tijeras
Bacaladera
Hachas
Espátulas y paletas
Abre - ostras
Rasqueta
Sierras
Guillotina, lira y rizador de queso
Abrelatas
Guantes
Delantales

130 - 143

144 - 153

154 - 175

10

Estanterías
Plataformas
Tarimas antifatiga
Palets
Losetas
Bancos de vestuario
Taquillas

Recambios

Anexos

176 - 191

192 - 195

196 - 199



1

Complementos

Tajos

Tacos de madera

Pilones

Polietileno

Mesas de madera

Mesas acero-inox

Artículos polietileno

Palas polietileno

Soporte tablas polietileno

1 COMPLEMENTOS

Todos nuestros productos fabricados están elaborados con maderas de encina, acacia, plátano y haya previamente seleccionada y tratada con riguroso proceso de secado para sustraer la humedad, savia y glutinosa de la madera, dejando todas las betas limpias para que dicho producto no tenga impurezas en su interior.

Consiguiendo con este proceso que al manipular los alimentos no desprendan ningún tipo de impurezas.

Para la conservación de la madera de nuestros productos fabricados, recomendamos usar nuestro rascador Ref. A-80 diariamente, para así conseguir mantener la superficie totalmente lisa y limpia.

No utilizando productos químicos que dañarían la conservación de nuestros pilones, tajos, tacos y mesas de madera.

Todos los productos están autorizados por sanidad.



Portacuchillos protegido, acero-inox
Con tres ranuras para cuchillos y chaira ovalada-redonda

| Ref. | Medidas | Euros |
|-------|----------------|--------|
| EC-10 | 38 x 9 x 38 cm | 120,00 |



Portacuchillos polietileno para EC-10

| Ref. | Medidas | Euros |
|-------|---------------------|-------|
| EC-11 | 37,7 x 8,6 x 1,5 cm | 27,00 |



Portacuchillo de madera

| Ref. | Euros |
|----------|-------|
| V-PORMAD | 20,00 |

Portacuchillo de polietileno

| Ref. | Color | Euros |
|-----------|-------|-------|
| V-PORPOLB | ● | 30,00 |
| V-PORPOLR | ● | 30,00 |

Portacuchillo de varilla acero-inox para tajo

| Ref. | Tipo | Euros |
|-------------|------|-------|
| V-PORACE-40 | 40 | 49,00 |
| V-PORACE-44 | 44 | 53,00 |
| V-PORACE-50 | 50 | 57,00 |



Rascador para limpieza de pilones y tajos de madera M

| Ref. | Euros |
|------|-------|
| A-80 | 21,50 |



Cepillo limpieza tablas polietileno 4 cortes

| Ref. | Euros |
|------|-------|
| A-81 | 38,00 |

Recambio cuchilla A-81

| Ref. | Tipo | Unidades | Euros |
|--------|----------|----------|-------|
| A-81-1 | 2 cortes | 1 | 19,00 |
| A-81-4 | 4 cortes | 2 | 25,00 |



Tope plástico colores A-AZ-B-N-R-RV-V

| Ref. | Euros |
|--------|-------|
| V-TOPE | 2,50 |



Guía tope vitrina inox

| Ref. | Medidas | Euros |
|-----------|---------------|-------|
| V-GUIA-40 | 40 x 3 x 2 cm | 7,50 |



Guía lateral

| Ref. | Medidas | Euros |
|-------------|---------------|-------|
| V-GUÍA 50 L | 50 x 5 x 2 cm | 12,00 |



Guía inferior

| Ref. | Medidas | Euros |
|-------------|---------------|-------|
| V-GUÍA 50 I | 50 x 3 x 2 cm | 11,00 |

Pie regulable para pata inox

| Ref. | Euros |
|------|-------|
| V-PR | 3,00 |

Pie fijo para patas inox

| Ref. | Euros |
|------|-------|
| V-PF | 1,50 |

Goma antideslizante

| Ref. | Euros |
|--------|-------|
| V-GOMA | 0,50 |



A - Tajo de 4 patas madera
Sin portacuchillos.
Altura total 90 cms.

| Ref. | Medida taco | Euros |
|-------------|------------------|---------|
| V-A604025E | 60 x 40 x 25 cm | 723,00 |
| V-A705025E | 70 x 50 x 25 cm | 982,00 |
| V-A804025E | 80 x 40 x 25 cm | 945,00 |
| V-A1005025E | 100 x 50 x 25 cm | 1277,00 |



A - Tajo de 4 patas madera
Sin portacuchillos.
Altura total 90 cms.

| Ref. | Medida taco | Euros |
|------------|-----------------|--------|
| V-A404025E | 40 x 40 x 25 cm | 518,00 |
| V-A444425E | 44 x 44 x 25 cm | 620,00 |
| V-A505025E | 50 x 50 x 25 cm | 716,00 |



A - Tajo de 4 patas madera
Sin portacuchillos.
Altura total 90 cms.

| Ref. | Medida taco | Euros |
|------------|-----------------|--------|
| V-A404015E | 40 x 40 x 15 cm | 416,00 |
| V-A443215E | 44 x 32 x 15 cm | 383,00 |
| V-A604015E | 60 x 40 x 15 cm | 540,00 |
| V-A806015E | 80 x 60 x 15 cm | 899,00 |



Tajo madera redondo

| Ref. | Diámetro | Altura | Euros |
|---------|----------|--------|---------|
| V-O6090 | Ø 60 cm | 90 cm | 2912,00 |



I-2 - Tajo de 4 patas de acero-inox sin faldón Sin portacuchillos. Altura total 90 cms.

| Ref. | Medida taco | Euros |
|--------------|------------------|---------|
| V-I2404025E | 40 x 40 x 25 cm | 625,00 |
| V-I2444425E | 44 x 44 x 25 cm | 738,00 |
| V-I2505025E | 50 x 50 x 25 cm | 848,00 |
| V-I2604025E | 60 x 40 x 25 cm | 835,00 |
| V-I2705025E | 70 x 50 x 25 cm | 1089,00 |
| V-I2804025E | 80 x 40 x 25 cm | 1030,00 |
| V-I21005025E | 100 x 50 x 25 cm | 1458,00 |



S - Tajo de 4 patas insonorizado de acero-inox Sin portacuchillo. Altura total 90 cms.

| Ref. | Medida taco | Euros |
|------------|-----------------|---------|
| V-S443225E | 44 x 32 x 25 cm | 1455,00 |
| V-S444425E | 44 x 44 x 25 cm | 1510,00 |
| V-S604025E | 60 x 40 x 25 cm | 1680,00 |
| V-S705025E | 70 x 50 x 25 cm | 1932,00 |

1 TACOS DE MADERA



O - Tacos de madera cuadrados

| Ref. | Medidas | Euros |
|------------|-----------------|--------|
| V-O404015E | 40 x 40 x 15 cm | 250,00 |
| V-O404025E | 40 x 40 x 25 cm | 373,00 |
| V-O444410E | 44 x 44 x 10 cm | 213,00 |
| V-O444420E | 44 x 44 x 20 cm | 437,00 |
| V-O444425E | 44 x 44 x 25 cm | 471,00 |
| V-O505025E | 50 x 50 x 25 cm | 574,00 |



O - Tacos de madera redondos

| Ref. | Diámetro | Altura | Euros |
|----------|----------|--------|--------|
| V-O3510E | Ø 35 cm | 10 cm | 252,00 |
| V-O3515E | Ø 35 cm | 15 cm | 314,00 |
| V-O3520E | Ø 35 cm | 20 cm | 398,00 |



G - Tacos de madera rectangulares

| Ref. | Medidas | Euros |
|-------------|------------------|---------|
| V-G37245E | 35 x 24 x 5 cm | 70,00 |
| V-G443210E | 44 x 32 x 10 cm | 168,00 |
| V-G443215E | 44 x 32 x 15 cm | 208,00 |
| V-G443220E | 44 x 32 x 20 cm | 381,00 |
| V-G443225E | 44 x 32 x 25 cm | 450,00 |
| V-G604025E | 60 x 40 x 25 cm | 560,00 |
| V-G705025E | 70 x 50 x 25 cm | 814,00 |
| V-G804025E | 80 x 40 x 25 cm | 780,00 |
| V-G1005025E | 100 x 50 x 25 cm | 1092,00 |
| V-G604015E | 60 x 40 x 15 cm | 356,00 |
| V-G806015E | 80 x 60 x 15 cm | 678,00 |



B - Pilón graduable descentrado expox
 Altura pie mínima 65 máxima 110 cm.
 Modelo ideal para espacios reducidos, trabajando la parte superior por encima del mostrador, evitando perjudicar con el golpe la vitrina. Al mismo tiempo aprovechamos la anchura del pasillo. Graduación a la altura de corte desea.
 Colocación: 4 tornillos al suelo.
 Se puede montar con tacos cuadrados ó polietileno.

| Ref. | Euros |
|--------|--------|
| V-BPGD | 336,00 |



B - Pilón graduable descentrado acero-inox
 Altura pie mínima 80, máxima 105 cm.
 Modelo ideal para espacios reducidos, trabajando la parte superior por encima del mostrador, evitando perjudicar con el golpe la vitrina. Al mismo tiempo aprovechamos la anchura del pasillo. Graduación a la altura de corte deseada.
 Colocación: 4 tornillos al suelo.
 Se puede montar con tacos cuadrados o redondos.

| Ref. | Euros |
|---------|--------|
| V-BPGDI | 768,00 |

1 TABLA DE CORTE MADERA



Tabla de corte en madera

| Ref. | Medidas | Euros |
|----------|------------------|--------|
| V-T30282 | 30 x 20 x 2 cm | 24,00 |
| V-T35252 | 35 x 25 x 2 cm | 32,00 |
| V-T50255 | 50 x 25 x 4,2 cm | 75,00 |
| V-T50355 | 50 x 35 x 4,2 cm | 104,00 |
| V-T50405 | 50 x 40 x 4,2 cm | 120,00 |
| V-T60505 | 60 x 50 x 4,2 cm | 175,00 |

TABLAS DE CORTE PE500 POLIETILENO EXTRUSIÓN, RECOMENDADO EN HOSTELERÍA Y DOMÉSTICO



| Medidas | 1 CM GROSOR | | 2 CM GROSOR | | 3 CM GROSOR | | 5 CM GROSOR | |
|------------|-------------|-------|-------------|-------|-------------|-------|-------------|--------|
| | REF | Euros | REF | Euros | REF | Euros | REF | Euros |
| 30 x 20 cm | Y-30201 | 6,00 | Y-30202 | 11,50 | Y-30203 | 17,25 | | |
| 40 x 30 cm | Y-40301 | 12,00 | Y-40302 | 21,00 | Y-40303 | 31,50 | | |
| 40 x 40 cm | | | Y-40402 | 28,00 | Y-40403 | 42,00 | Y-40405 | 70,00 |
| 45 x 45 cm | | | | | | | Y-45455 | 92,00 |
| 50 x 30 cm | | | Y-50302 | 26,25 | Y-50303 | 39,50 | | |
| 50 x 50 cm | | | Y-50502 | 43,75 | Y-50503 | 66,00 | Y-50505 | 108,00 |
| 60 x 40 cm | | | Y-60402 | 42,00 | Y-60403 | 63,00 | Y-60405 | 105,00 |
| 70 x 50 cm | | | | | | | Y-70505 | 154,00 |

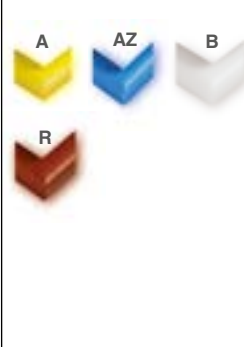
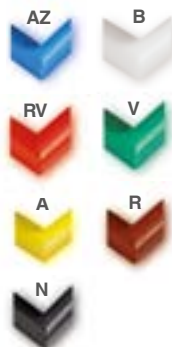
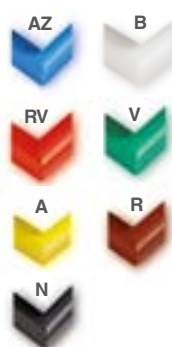

A= Amarillo AZ= Azul B= Blanco

N= Negro R= Rojo RV= Rojo Vivo

V= Verde

**H - Tablas de polietileno
Grosor 1,5 cm**

| Ref. | Medidas | Euros |
|--------------|-----------|--------|
| V-H25191.5 | 25 x 19 | 9,10 |
| V-H30201.5 | 30 x 20 | 10,85 |
| V-H33191.5 | 33 x 19 | 12,00 |
| V-H33331.5 | 33 x 33 | 19,75 |
| V-H40201.5 | 40 x 20 | 14,50 |
| V-H40251.5 | 40 x 25 | 18,10 |
| V-H40301.5 | 40 x 30 | 21,75 |
| V-H40331.5 | 40 x 33 | 23,95 |
| V-H40401.5 | 40 x 40 | 29,00 |
| V-H50251.5 | 50 x 25 | 22,60 |
| V-H50301.5 | 50 x 30 | 27,10 |
| V-H50331.5 | 50 x 33 | 29,80 |
| V-H50401.5 | 50 x 40 | 36,20 |
| V-H50501.5 | 50 x 50 | 45,15 |
| V-H60251.5 | 60 x 25 | 27,10 |
| V-H60301.5 | 60 x 30 | 32,55 |
| V-H60331.5 | 60 x 33 | 35,80 |
| V-H60401.5 | 60 x 40 | 43,35 |
| V-H75251.5 | 75 x 25 | 33,85 |
| V-H75331.5 | 75 x 33 | 44,75 |
| V-H100251.5 | 100 x 25 | 45,15 |
| V-H100331.5 | 100 x 33 | 59,65 |
| V-H150251.5 | 150 x 25 | 67,70 |
| V-H150331.5 | 150 x 33 | 89,40 |
| V-H200251.5 | 200 x 25 | 90,30 |
| V-H200331.5 | 200 x 33 | 119,20 |
| V-H2001001.5 | 200 x 100 | 361,00 |

**H - Tablas de polietileno
Grosor 2 cm**

| Ref. | Medidas | Euros |
|------------|-----------|--------|
| V-H25192 | 25 x 19 | 11,25 |
| V-H30202 | 30 x 20 | 13,45 |
| V-H33192 | 33 x 19 | 14,80 |
| V-H33332 | 33 x 33 | 24,40 |
| V-H40202 | 40 x 20 | 17,95 |
| V-H40252 | 40 x 25 | 22,40 |
| V-H40302 | 40 x 30 | 26,90 |
| V-H40332 | 40 x 33 | 29,60 |
| V-H40402 | 40 x 40 | 35,85 |
| V-H50252 | 50 x 25 | 28,05 |
| V-H50302 | 50 x 30 | 33,50 |
| V-H50332 | 50 x 33 | 36,90 |
| V-H50402 | 50 x 40 | 44,75 |
| V-H50502 | 50 x 50 | 55,90 |
| V-H60252 | 60 x 25 | 33,55 |
| V-H60302 | 60 x 30 | 40,15 |
| V-H60332 | 60 x 33 | 44,30 |
| V-H60402 | 60 x 40 | 53,70 |
| V-H75252 | 75 x 25 | 41,95 |
| V-H75332 | 75 x 33 | 55,40 |
| V-H100252 | 100 x 25 | 55,90 |
| V-H100332 | 100 x 33 | 73,80 |
| V-H150252 | 150 x 25 | 83,90 |
| V-H150332 | 150 x 33 | 110,70 |
| V-H200252 | 200 x 25 | 111,80 |
| V-H200332 | 200x 33 | 147,60 |
| V-H2001002 | 200 x 100 | 447,00 |

**H - Tablas de polietileno
Grosor 3 cm**

| Ref. | Medidas | Euros |
|------------|-----------|--------|
| V-H25193 | 25 x 19 | 16,80 |
| V-H30203 | 30 x 20 | 20,15 |
| V-H33193 | 33 x 19 | 22,15 |
| V-H33333 | 33 x 33 | 36,55 |
| V-H40203 | 40 x 20 | 26,90 |
| V-H40253 | 40 x 25 | 33,60 |
| V-H40303 | 40 x 30 | 40,30 |
| V-H40333 | 40 x 33 | 44,35 |
| V-H40403 | 40 x 40 | 53,75 |
| V-H50253 | 50 x 25 | 42,00 |
| V-H50303 | 50 x 30 | 50,40 |
| V-H50333 | 50 x 33 | 55,45 |
| V-H50403 | 50 x 40 | 67,20 |
| V-H50503 | 50 x 50 | 84,00 |
| V-H60253 | 60 x 25 | 50,40 |
| V-H60303 | 60 x 30 | 60,50 |
| V-H60333 | 60 x 33 | 66,55 |
| V-H60403 | 60 x 40 | 80,65 |
| V-H75253 | 75 x 25 | 62,95 |
| V-H75333 | 75 x 33 | 83,05 |
| V-H100253 | 100 x 25 | 83,90 |
| V-H100333 | 100 x 33 | 110,70 |
| V-H150253 | 150 x 25 | 125,85 |
| V-H150333 | 150 x 33 | 166,10 |
| V-H200253 | 200 x 25 | 168,00 |
| V-H200333 | 200 x 33 | 221,55 |
| V-H2001003 | 200 x 100 | 671,00 |



MN= Marmóreo N/B
M= Marmóreo R/B
B= Blanco

A= Amarillo
S= Salmón
R= Rojo

V= Verde
AZ= Azul
N= Negro

RV= Rojo Vivo

1 TABLAS DE CORTE PE500 POLIETILENO Prensado RECOMENDADO PARA ALIMENTACIÓN AUMENTANDO UN 20% SU DURABILIDAD

H - Tablas de polietileno Grosor 4 cm

| Ref. | Medidas | Euros |
|------------|-----------|--------|
| V-H25194 | 25 x 19 | 22,35 |
| V-H30204 | 30 x 20 | 26,90 |
| V-H33194 | 33 x 19 | 29,55 |
| V-H33334 | 33 x 33 | 48,70 |
| V-H40204 | 40 x 20 | 35,80 |
| V-H40254 | 40 x 25 | 44,70 |
| V-H40304 | 40 x 30 | 53,70 |
| V-H40334 | 40 x 33 | 59,05 |
| V-H40404 | 40 x 40 | 71,60 |
| V-H50254 | 50 x 25 | 55,90 |
| V-H50304 | 50 x 30 | 67,10 |
| V-H50334 | 50 x 33 | 73,80 |
| V-H50404 | 50 x 40 | 89,45 |
| V-h50504 | 50 x 50 | 111,80 |
| V-H60254 | 60 x 25 | 67,10 |
| V-H60304 | 60 x 30 | 80,55 |
| V-H60334 | 60 x 33 | 88,60 |
| V-H60404 | 60 x 40 | 107,40 |
| V-H75254 | 75 x 25 | 83,90 |
| V-H75334 | 75 x 33 | 110,70 |
| V-H100254 | 100 x 25 | 111,80 |
| V-H100334 | 100 x 33 | 147,60 |
| V-H150254 | 150 x 25 | 167,75 |
| V-H150334 | 150 x 33 | 221,45 |
| V-H200254 | 200 x 25 | 223,65 |
| V-H200334 | 200 x 33 | 295,25 |
| V-H2001004 | 200 x 100 | 895,00 |

Tablas de polietileno Grosor 5 cm

| Ref. | Medidas | Euros |
|------------|-----------|---------|
| V-H25195 | 25 x 19 | 28,00 |
| V-H30205 | 30 x 20 | 33,55 |
| V-H33195 | 33 x 19 | 36,90 |
| V-H33335 | 33 x 33 | 60,90 |
| V-H40205 | 40 x 20 | 44,70 |
| V-H40255 | 40 x 25 | 55,90 |
| V-H40305 | 40 x 30 | 67,10 |
| V-H40335 | 40 x 33 | 73,80 |
| V-H40405 | 40 x 40 | 89,45 |
| V-H45455 | 45 x 45 | 113,90 |
| V-H50255 | 50 x 25 | 69,95 |
| V-H50305 | 50 x 30 | 83,90 |
| V-H50335 | 50 x 33 | 92,30 |
| V-H50405 | 50 x 40 | 118,80 |
| V-H50505 | 50 x 50 | 139,90 |
| V-H60255 | 60 x 25 | 83,90 |
| V-H60305 | 60 x 30 | 100,65 |
| V-H60335 | 60 x 33 | 110,70 |
| V-H60405 | 60 x 40 | 134,20 |
| V-H65455 | 65 x 45 | 183,75 |
| V-H70505 | 70 x 50 | 195,70 |
| V-H75255 | 75 x 25 | 104,85 |
| V-H75335 | 75 x 33 | 138,40 |
| V-H80405 | 80 x 40 | 178,90 |
| V-H90455 | 90 x 45 | 239,40 |
| V-H100255 | 100 x 25 | 139,90 |
| V-H100335 | 100 x 33 | 184,50 |
| V-H100505 | 100 x 50 | 279,55 |
| V-H150255 | 150 x 25 | 209,70 |
| V-H150335 | 150 x 33 | 276,75 |
| V-H200255 | 200 x 25 | 280,00 |
| V-H200335 | 200 x 33 | 369,60 |
| V-H2001005 | 200 x 100 | 1118,00 |

LAS TABLAS REDONDAS Y LAS TABLAS PARA ACOPLAR SE INCREMENTARÁN 20,00 euros. /

| | PRECIO CORTE CM ² EUROS | COLORES |
|---------------------|------------------------------------|------------------------|
| 0,3 CM ² | 0,0055 | B |
| 1 CM ² | 0,0145 | B |
| 1,5 CM ² | 0,0198 | B-R-M |
| 2 CM ² | 0,0245 | B-R-M-A-AZ-S-V-N-RV-MN |
| 3 CM ² | 0,0368 | B-R-M |
| 4 CM ² | 0,0490 | B-R-M-A-AZ-S-V-N-RV-MN |
| 5 CM ² | 0,0613 | B-R-M-A-AZ |
| 9 CM ² | 0,1200 | B-R |
| 14 CM ² | 0,2100 | B-R |

LARGO x ANCHO x EUROS CM².
EJEMPLO: TABLA MEDIDA 55x28x3.
PRECIO: 55 x 28 x 0,0368 = 56,67 euros.

MN
M
B
A
S
R
V
RV
AZ
N

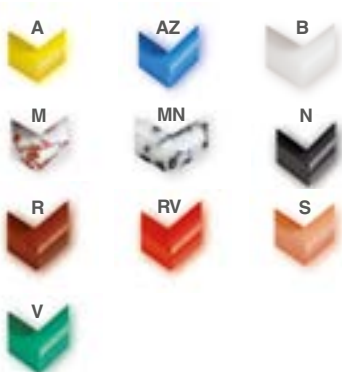

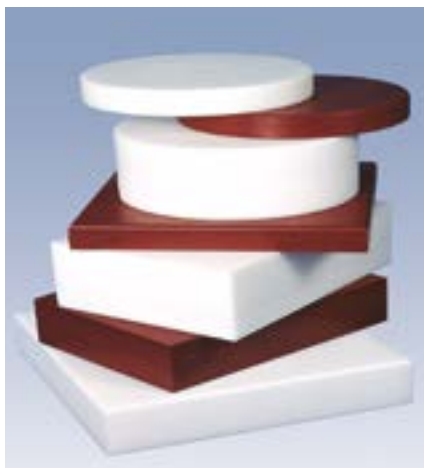

**Tablas de polietileno
En Blanco (Ref + B) y Rojo (Ref + R)**

| Ref. | Medidas | Euros |
|-----------|-----------------|--------|
| V-H40339 | 40 x 33 x 9 cm | 141,00 |
| V-H40409 | 40 x 40 x 9 cm | 171,00 |
| V-H45459 | 45 x 45 x 9 cm | 235,00 |
| V-H50339 | 50 x 33 x 9 cm | 176,00 |
| V-H50509 | 50 x 50 x 9 cm | 267,00 |
| V-H60409 | 60 x 40 x 9 cm | 256,00 |
| V-H403314 | 40 x 33 x 14 cm | 249,00 |
| V-H503314 | 50 x 33 x 14 cm | 312,50 |

**Tablas redondo de polietileno
En Blanco (Ref + B) y Rojo (Ref + R)**

| Ref. | Diámetro | Altura | Euros |
|---------|----------|--------|--------|
| V-H355 | Ø 35 cm | 5 cm | 95,50 |
| V-H359 | Ø 35 cm | 9 cm | 167,00 |
| V-H3514 | Ø 35 cm | 14 cm | 297,00 |
| V-H405 | Ø 40 cm | 5 cm | 118,00 |
| V-H409 | Ø 40 cm | 9 cm | 212,00 |
| V-H4014 | Ø 40 cm | 14 cm | 320,00 |

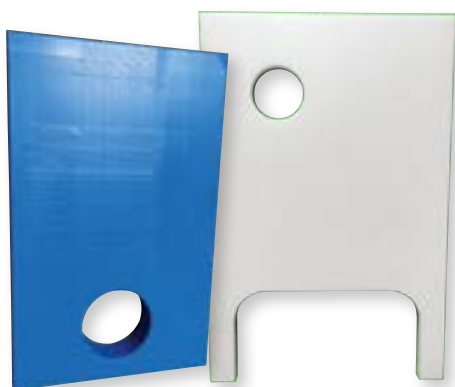

Agujero para tabla

| Ref. | Altura | Euros |
|----------|--------|-------|
| V-HAGU5 | 5 cm | 40,00 |
| V-HAGU9 | 9 cm | 55,00 |
| V-HAGU14 | 14 cm | 75,00 |

ARTÍCULOS MESA POLIETILENO PE 500



**Tabla canal recoge-jugos
En Blanco (Ref + B) y Rojo (Ref + R)**

| Ref. | Medidas | Euros |
|-----------|----------------|-------|
| V-HC3320 | 33 x 20 x 1,5 | 19,50 |
| V-HC5020 | 50 x 20 x 1,5 | 32,00 |
| V-HC10020 | 100 x 20 x 1,5 | 52,00 |

Plato pulpo

| Ref. | Diámetro | Altura | Euros |
|---------|----------|--------|-------|
| A-48-18 | Ø 18 cm | 2 cm | 22,00 |
| A-48-22 | Ø 22 cm | 2 cm | 28,00 |
| A-48-26 | Ø 26 cm | 2 cm | 36,00 |

TACO MADERA CON POLIETILENO



**F - Taco madera fabricado en cuadradillo
y 5 cm polietileno rectangulares
En Blanco (Ref + B) y Rojo (Ref + R)**

| Ref. | Medida taco | Euros | Ref. | Medida taco | Euros |
|-------------|-----------------|--------|-------------|-----------------|--------|
| V-F604025PL | 60 x 40 x 25 cm | 357,00 | V-F454525PL | 45 x 45 x 25 cm | 302,00 |
| V-F705025PL | 70 x 50 x 25 cm | 524,00 | V-F505025PL | 50 x 50 x 25 cm | 372,00 |
| V-F404025PL | 40 x 40 x 25 cm | 239,00 | | | |

1 TAJO DE 4 PATAS CON TACO MADERA Y SOBRE DE POLIETILENO



F - Tajo de 4 patas insonorizado de acero-inox (Ref. S) con taco de madera fabricado en cuadradillo + 5 cm polietileno
Sin portacuchillo.
Altura total 85 cm.
En Blanco (Ref + B) y Rojo (Ref + R)

| Ref. | Medida taco | Euros |
|--------------|-----------------|---------|
| V-FS454520PL | 45 x 45 x 25 cm | 1350,00 |
| V-FS604020PL | 60 x 40 x 25 cm | 1485,00 |
| V-FS705020PL | 70 x 50 x 25 cm | 1694,00 |



F - Tajo de 4 patas de madera (Ref. A) con taco de madera fabricado en cuadradillo + 5 cm polietileno
Sin portacuchillos.
Altura total 85 cm. En Blanco (Ref + B) y Rojo (Ref + R)

| Ref. | Medida taco | Euros |
|---------------|------------------|--------|
| V-FA404020PL | 40 x 40 x 25 cm | 386,00 |
| V-FA454520PL | 45 x 45 x 25 cm | 454,00 |
| V-FA505020PL | 50 x 50 x 25 cm | 535,00 |
| V-FA604020PL | 60 x 40 x 25 cm | 520,00 |
| V-FA705020PL | 70 x 50 x 25 cm | 692,00 |
| V-FA1005020PL | 100 x 50 x 25 cm | 909,00 |



F - Tajo de 4 patas de acero-inox sin faldón (Ref. I-2) con taco de madera fabricado en cuadradillo + 5 cm polietileno
Sin portacuchillos.
Altura total 85 cm.
En Blanco (Ref + B) y Rojo (Ref + R)

| Ref. | Medida taco | Euros |
|----------------|------------------|---------|
| V-FI2404020PL | 40 x 40 x 25 cm | 537,00 |
| V-FI2454520PL | 45 x 45 x 25 cm | 598,00 |
| V-FI2505020PL | 50 x 50 x 25 cm | 684,00 |
| V-FI2604020PL | 60 x 40 x 25 cm | 668,00 |
| V-FI2705020PL | 70 x 50 x 25 cm | 846,00 |
| V-FI21005020PL | 100 x 50 x 25 cm | 1108,00 |



P - Mesa total de polietileno con sobre de polietileno 4 cm, Altura total 90 cm
Disponibile en todos los colores

| Ref. | Medidas | Euros |
|----------|------------|--------|
| V-P40404 | 40 x 40 cm | 298,00 |
| V-P45454 | 45 x 45 cm | 332,00 |
| V-P50504 | 50 x 50 cm | 360,00 |
| V-P60404 | 60 x 40 cm | 356,00 |
| V-P70504 | 70 x 50 cm | 420,00 |

MESAS DE CORTE



L-2 - Mesa de madera sin faldón y sobre de polietileno
Polietileno 5 cm
Altura total 90 cm
En Blanco (Ref + B) y Rojo (Ref + R)

| Ref. | Medidas | Euros |
|-----------|------------|--------|
| V-L240405 | 40 x 40 cm | 277,00 |
| V-L245455 | 45 x 45 cm | 312,00 |
| V-L250505 | 50 x 50 cm | 349,00 |
| V-L260405 | 60 x 40 cm | 344,00 |
| V-L270505 | 70 x 50 cm | 427,00 |

Mesa de madera sin faldón y sobre de polietileno
Polietileno 9 cm
Altura total 94 cm
En Blanco (Ref + B) y Rojo (Ref + R)

| Ref. | Medidas | Euros |
|-----------|------------|--------|
| V-L240409 | 40 x 40 cm | 382,00 |
| V-L245459 | 45 x 45 cm | 457,00 |
| V-L250509 | 50 x 50 cm | 506,00 |
| V-L260409 | 60 x 40 cm | 492,00 |
| V-L270509 | 70 x 50 cm | 695,00 |

1 TAJOS DE CORTE CON POLIETILENO



**K - Mesa de acero-inox con faldón y estante sobre de polietileno
Polietileno 5 cm
Altura total 90 cm
En Blanco (Ref + B) y Rojo (Ref + R)**

| Ref. | Medidas | Euros |
|----------|------------|--------|
| V-K40405 | 40 x 40 cm | 419,00 |
| V-K45455 | 45 x 45 cm | 468,00 |
| V-K50505 | 50 x 50 cm | 495,00 |
| V-K60405 | 60 x 40 cm | 491,00 |
| V-K70505 | 70 x 50 cm | 588,00 |

**Mesa de acero-inox con faldón y estante sobre de polietileno
Polietileno 9 cm
Altura total 94 cm
En Blanco (Ref + B) y Rojo (Ref + R)**

| Ref. | Medidas | Euros |
|----------|------------|--------|
| V-K40409 | 40 x 40 cm | 527,00 |
| V-K45459 | 45 x 45 cm | 593,00 |
| V-K50509 | 50 x 50 cm | 649,00 |
| V-K60409 | 60 x 40 cm | 639,00 |
| V-K70509 | 70 x 50 cm | 848,00 |



**K-5 - Mesa de acero-inox pesada con faldón y estante sobre de polietileno
Polietileno 5 cm
Altura total 90 cm
En Blanco (Ref + B) y Rojo (Ref + R)**

| Ref. | Medidas | Euros |
|-----------|------------|--------|
| V-K540405 | 40 x 40 cm | 548,00 |
| V-K545455 | 45 x 45 cm | 598,00 |
| V-K550505 | 50 x 50 cm | 647,00 |
| V-K560405 | 60 x 40 cm | 625,00 |
| V-K570505 | 70 x 50 cm | 747,00 |

**Mesa de acero-inox pesada con faldón y estante sobre de polietileno
Polietileno 9 cm
Altura total 94 cm
En Blanco (Ref + B) y Rojo (Ref + R)**

| Ref. | Medidas | Euros |
|-----------|------------|---------|
| V-K540409 | 40 x 40 cm | 641,00 |
| V-K545459 | 45 x 45 cm | 723,00 |
| V-K550509 | 50 x 50 cm | 786,00 |
| V-K560409 | 60 x 40 cm | 776,00 |
| V-K570509 | 70 x 50 cm | 1011,00 |



MI - Mesa total de acero-inox desmontable con estante
 Altura total 85 cm.

| Ref. | Medidas | Euros |
|------------|-------------|--------|
| V-MI10060C | 100 x 60 cm | 625,00 |
| V-MI10070C | 100 x 70 cm | 661,00 |
| V-MI15060C | 150 x 60 cm | 732,00 |
| V-MI15070C | 150 x 70 cm | 803,00 |
| V-MI20060C | 200 x 60 cm | 880,00 |
| V-MI20070C | 200 x 70 cm | 988,00 |

MI - Mesa total de acero-inox desmontable sin estante
 Altura total 85 cm.

| Ref. | Medidas | Euros |
|------------|-------------|--------|
| V-MI10060S | 100 x 60 cm | 590,00 |
| V-MI10070S | 100 x 70 cm | 617,00 |
| V-MI15060S | 150 x 60 cm | 678,00 |
| V-MI15070S | 150 x 70 cm | 734,00 |
| V-MI20060S | 200 x 60 cm | 826,00 |
| V-MI20070S | 200 x 70 cm | 910,00 |



Mesa acero-inox para cortadoras 2 estantes

| Ref. | Medidas | Euros |
|----------|-----------------|--------|
| V-MI7050 | 70 x 50 x 85 cm | 540,00 |



Mesa acero-inox para sierra 1 estante

| Ref. | Medidas | Euros |
|----------|-----------------|--------|
| V-MI5050 | 50 x 50 x 65 cm | 386,00 |

1 ARTÍCULOS MESA POLIETILENO PE 500



Triángulo para colador chino 45 cm

| Ref. | Euros |
|------|-------|
| A-41 | 30,00 |

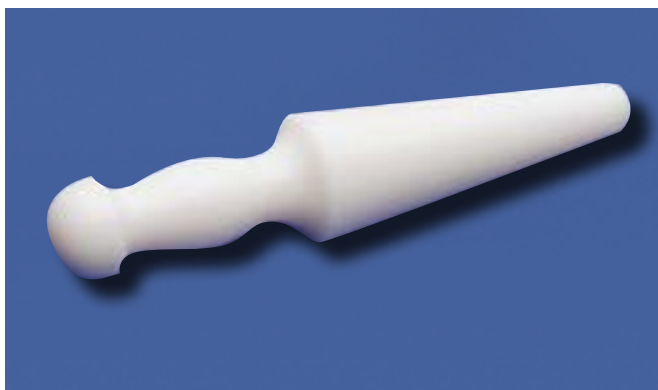

Mano para colador chino

| Ref. | Euros |
|------|-------|
| A-42 | 35,00 |



Tabla ranuras pan, salmón

| Ref. | Medidas | Euros |
|--------------|----------------|-------|
| V-HRP-40302S | 40 x 30 x 2 cm | 39,00 |



Mortero sin mano

| Ref. | Medidas | Euros |
|------|---------|-------|
| A-43 | Ø 18 cm | 90,00 |



Mano mortero A-43

| Ref. | Medidas | Euros |
|------|-----------|-------|
| A-44 | 20 x 5 cm | 19,00 |

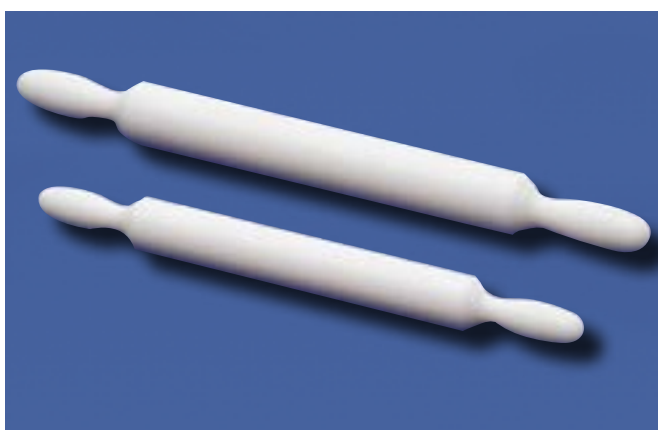

Rodillo amasador

| Ref. | Diámetro | Largo | Euros |
|------|----------|-------|-------|
| A-46 | Ø 5 cm | 50 cm | 35,00 |
| A-47 | Ø 6 cm | 60 cm | 43,00 |

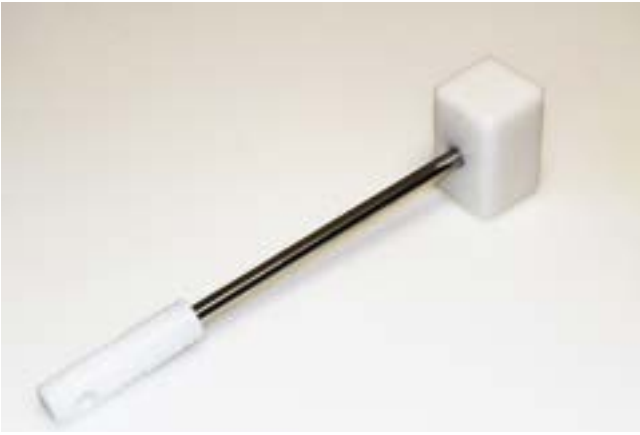

Maza para picar hielo Polietileno + Inox.

| Ref. | Medidas | Euros |
|------|---------------|-------|
| A-57 | 6 x 6 x 10 cm | 24,50 |

PALAS POLIETILENO

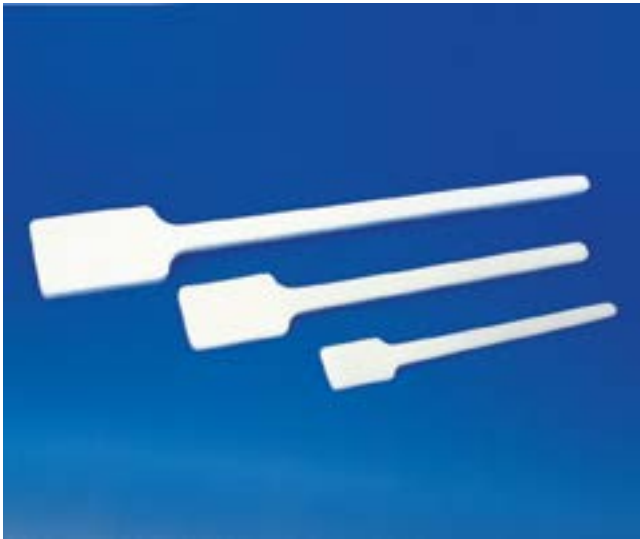

Pala polietileno

| Ref. | Largo | Euros |
|----------|--------|-------|
| A-30-50 | 50 cm | 16,00 |
| A-30-70 | 70 cm | 24,00 |
| A-30-100 | 100 cm | 34,00 |



Pala polietileno + inox

| Ref. | Largo | Euros |
|------------|--------|-------|
| A-30-50-I | 50 cm | 46,00 |
| A-30-70-I | 70 cm | 49,00 |
| A-30-100-I | 100 cm | 65,00 |

1 SOPORTE TABLAS POLIETILENO

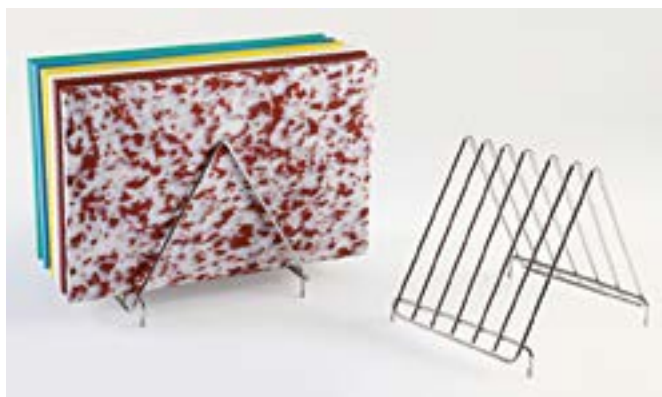

Soporte tabla polietileno acero-inox (máx. grueso 3 cm)

| Ref. | Euros |
|-------|-------|
| SPI-6 | 38,00 |

ARTÍCULOS MESA POLIETILENO MADERA



Soporte polietileno

| Ref. | Medidas | Color | Euros |
|--------|----------------|-------|-------|
| V-SP2B | 27 x 19 x 3 cm | ● | 35,00 |
| V-SP2R | 27 x 19 x 3 cm | ● | 35,00 |

Soporte polietileno mármereo

| Ref. | Medidas | Euros |
|--------|----------------|-------|
| V-SP2M | 27 x 19 x 3 cm | 35,00 |



Tabla corte con cubeta Con guías para cubeta gastronorm GI-1/2-65. Altura 10 cm

| Ref. | Medidas | Euros |
|------------|----------------|-------|
| V-HG40302V | 40 x 30 x 2 cm | 79,50 |



Tabla madera presentación Con dos listones inferiores

| Ref. | Medidas | Euros |
|-----------|----------------|-------|
| V-TP30202 | 30 x 20 x 2 cm | 35,00 |
| V-TP35252 | 35 x 25 x 2 cm | 49,00 |

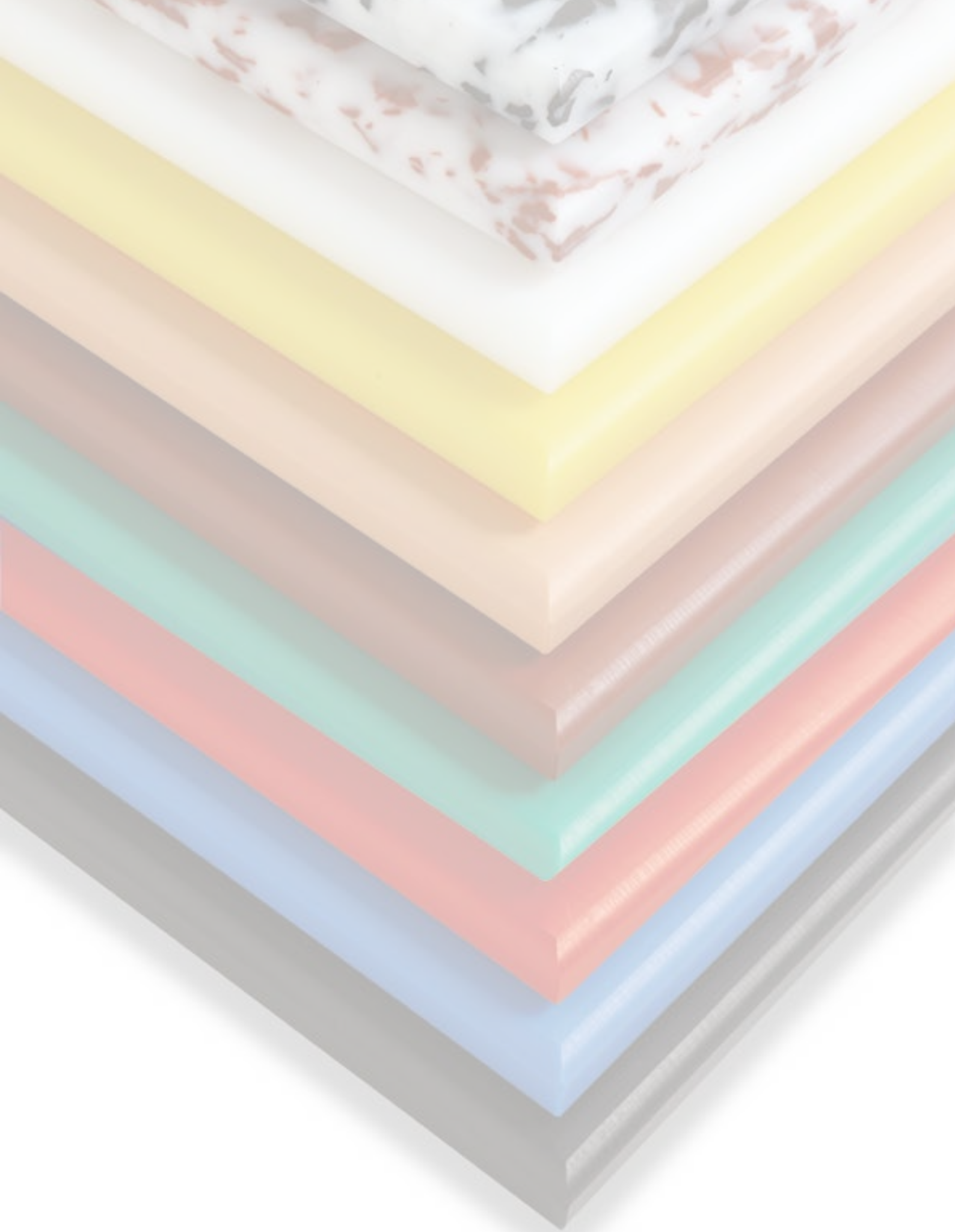



2

Carteles portaprecios

Soportes carteles

Carteles señalización

Guirnaldas

Separadores

Decoración

Barreños industriales

Cubetas

Base rodante

Bandejas

Gastronorm

PlexiLine



Porcino, num. relieve

| Ref. | Medidas | Unidades | Euros |
|-------|-----------|----------|-------|
| C-300 | 8,5 x 6,5 | 12 | 72,00 |



Ternera, num. relieve, con base

| Ref. | Medidas | Unidades | Euros |
|-------|-----------|----------|-------|
| C-301 | 8,5 x 6,5 | 12 | 72,00 |



Cordero, num. relieve, con base

| Ref. | Medidas | Unidades | Euros |
|-------|-----------|----------|-------|
| C-302 | 8,5 x 6,5 | 12 | 72,00 |



Pollo, num. relieve, con base

| Ref. | Medidas | Unidades | Euros |
|-------|-----------|----------|-------|
| C-303 | 8,5 x 6,5 | 12 | 72,00 |



Charcutería, num. relieve, con base

| Ref. | Medidas | Unidades | Euros |
|-------|-----------|----------|-------|
| C-304 | 8,5 x 6,5 | 12 | 72,00 |



Quesos, num. relieve, con base

| Ref. | Medidas | Unidades | Euros |
|-------|-----------|----------|-------|
| C-305 | 8,5 x 6,5 | 12 | 72,00 |



Liso Pizarra

| Ref. | Medidas | Unidades | Euros |
|-------|--------------|----------|-------|
| C-307 | 8,5 x 6,5 cm | 12 | 72,00 |



Panadería/Pastelería, num. relieve, con base

| Ref. | Medidas | Unidades | Euros |
|-------|-----------|----------|-------|
| C-306 | 8,5 x 6,5 | 12 | 72,00 |



Porcino, num. relieve, con base

| Ref. | Medidas | Unidades | Euros |
|-------|------------|----------|-------|
| C-310 | 10,5 x 7,5 | 12 | 75,00 |



Ternera, num. relieve, con base

| Ref. | Medidas | Unidades | Euros |
|-------|------------|----------|-------|
| C-311 | 10,5 x 7,5 | 12 | 75,00 |



Cordero, num. relieve, con base

| Ref. | Medidas | Unidades | Euros |
|-------|------------|----------|-------|
| C-312 | 10,5 x 7,5 | 12 | 75,00 |



Pollo, num. relieve, con base

| Ref. | Medidas | Unidades | Euros |
|-------|------------|----------|-------|
| C-313 | 10,5 x 7,5 | 12 | 75,00 |



Charcutería, num. relieve, con base

| Ref. | Medidas | Unidades | Euros |
|-------|------------|----------|-------|
| C-314 | 10,5 x 7,5 | 12 | 75,00 |



Quesos, num. relieve, con base

| Ref. | Medidas | Unidades | Euros |
|-------|------------|----------|-------|
| C-315 | 10,5 x 7,5 | 12 | 75,00 |



Liso pizarra

| Ref. | Medidas | Unidades | Euros |
|-------|---------------|----------|-------|
| C-317 | 10,5 x 7,5 cm | 12 | 75,00 |



Frutas, nº relieve, con ganchos

| Ref. | Medidas | Unidades | Euros |
|-------|----------|----------|-------|
| C-320 | 13 x 9,5 | 12 | 78,00 |

2 CARTELES PORTAPRECIOS

Material Glaspar, con pincho acero-inoxidable, arandela de plástico y remaches de plástico



Nº ruedas, fondo rojo

| Ref. | Medidas | Unidades | Euros |
|------|---------|----------|-------|
| C-10 | 8 x 7 | 12 | 30,00 |



Nº ruedas 8x7 fondo azul

| Ref. | Medidas | Unidades | Euros |
|---------|---------|----------|-------|
| C-10-AZ | 8 x 7 | 12 | 30,00 |



Nº ruedas, fondo blanco

| Ref. | Medidas | Unidades | Euros |
|--------|---------|----------|-------|
| C-10-B | 8 x 7 | 12 | 30,00 |



Nº ruedas 10x7,5 cm. fondo rojo

| Ref. | Medidas | Unidades | Euros |
|------|----------|----------|-------|
| C-11 | 10 x 7,5 | 12 | 31,00 |



Nº ruedas, fondo azul

| Ref. | Medidas | Unidades | Euros |
|---------|----------|----------|-------|
| C-11-AZ | 10 x 7,5 | 12 | 31,00 |



Nº ruedas, fondo blanco

| Ref. | Medidas | Unidades | Euros |
|--------|----------|----------|-------|
| C-11-B | 10 x 7,5 | 12 | 31,00 |



Rotulación cartel indicando producto

| Ref. | Euros |
|------|-------|
| C-51 | 1,00 |



Visera oferta para carteles ruedas

| Ref. | Unidades | Euros |
|------|----------|-------|
| C-2 | 12 | 17,50 |



Rotulador para carteles digitales y rotulación producto

| Ref. | Euros |
|-------|-------|
| C-100 | 5,00 |



Nº ruedas, rojo, con rueda para indicar kg-unidades-100gr. - 1/4

| Ref. | Medidas | Unidades | Euros |
|--------|----------|----------|-------|
| C-65-R | 11 x 7,5 | 12 | 35,00 |



Nº ruedas, azul, con rueda para indicar kilo-unid. -100 gr., 1/4

| Ref. | Medidas | Unidades | Euros |
|---------|----------|----------|-------|
| C-65-AZ | 11 x 7,5 | 12 | 35,00 |



Nº ruedas, verde, con rueda para indicar kilo-unidad - 100 gr. - 1/4

| Ref. | Medidas | Unidades | Euros |
|--------|----------|----------|-------|
| C-65-V | 11 x 7,5 | 12 | 35,00 |



Nº ruedas, blanco, con rueda para indicar kilo-unid.- 100 gr. - 1/4

| Ref. | Medidas | Unidades | Euros |
|--------|----------|----------|-------|
| C-65-B | 11 x 7,5 | 12 | 35,00 |



Nº ruedas, rojo con rueda para indicar kilo-unid. - 100 gr. - 1/4

| Ref. | Medidas | Unidades | Euros |
|---------|----------|----------|-------|
| C-65-RB | 11 x 7,5 | 12 | 44,00 |



Nº ruedas, azul con rueda para indicar kilo-unid. - 100 gr. - 1/4, con base

| Ref. | Medidas | Unidades | Euros |
|----------|----------|----------|-------|
| C-65-AZB | 11 x 7,5 | 9 | 44,00 |



Nº ruedas verde, con rueda para indicar Kg-unid.-100 gr.-1/4, con base

| Ref. | Medidas | Unidades | Euros |
|---------|----------|----------|-------|
| C-65-VB | 11 x 7,5 | 12 | 44,00 |



Nº ruedas, blanco, con rueda para indicar kilo-unid.- 100 gr. - 1/4

| Ref. | Medidas | Unidades | Euros |
|---------|----------|----------|-------|
| C-65-BB | 11 x 7,5 | 12 | 44,00 |

2 CARTELES PORTAPRECIOS



Nº ruedas, pergamino, con rueda para indicar kilo-unidad - 100 gr. - 1/4

| Ref. | Medidas | Unidades | Euros |
|------|----------|----------|-------|
| C-66 | 11 x 7,5 | 12 | 37,00 |



Liso

| Ref. | Medidas | Unidades | Euros |
|------|---------|----------|-------|
| C-7 | 10 x 7 | 12 | 25,00 |



Nº ruedas, pergamino, con rueda para indicar Kg.-unid.-100 gr.-1/4, con base

| Ref. | Medidas | Unidades | Euros |
|--------|----------|----------|-------|
| C-66-B | 11 x 7,5 | 12 | 45,00 |



Liso con base

| Ref. | Medidas | Unidades | Euros |
|-------|---------|----------|-------|
| C-7-B | 10 x 7 | 12 | 32,50 |



Porta tarjeta transparente con base

| Ref. | Medidas | Unidades | Euros |
|-------|---------|----------|-------|
| C-132 | 9,5 x 7 | 12 | 25,00 |



Guía adhesiva para etiquetas, transparente

| Ref. | Medidas | Unidades | Euros |
|-------|---------|----------|-------|
| C-130 | 10 x 4 | 12 | 12,00 |



Guía adhesiva para etiquetas, 100x4 cm, transparente

| Ref. | Euros |
|-------|-------|
| C-131 | 10,00 |

Material : Plástico inyectado - Pincho : Acero inox. - Números : Relieve



Inyección, N° relieve, azul

| Ref. | Medidas | Unidades | Euros |
|---------|---------|----------|--------|
| C-44-AZ | 9 x 7,5 | 24 | 107,00 |



Inyección, N° relieve, blanco

| Ref. | Medidas | Unidades | Euros |
|--------|---------|----------|--------|
| C-44-B | 9 x 7,5 | 24 | 107,00 |



Inyección, N° relieve, crema

| Ref. | Medidas | Unidades | Euros |
|--------|---------|----------|--------|
| C-44-C | 9 x 7,5 | 24 | 107,00 |



Inyección, N° relieve, marrón

| Ref. | Medidas | Unidades | Euros |
|--------|---------|----------|--------|
| C-44-M | 9 x 7,5 | 24 | 107,00 |



Inyección, N° relieve, rojo

| Ref. | Medidas | Unidades | Euros |
|--------|---------|----------|--------|
| C-44-R | 9 x 7,5 | 24 | 107,00 |



Inyección, N° relieve, blanco masa azul

| Ref. | Medidas | Unidades | Euros |
|----------|---------|----------|--------|
| C-44-BAZ | 9 x 7,5 | 24 | 107,00 |



Inyección, N° relieve, blanco masa rojo

| Ref. | Medidas | Unidades | Euros |
|---------|---------|----------|--------|
| C-44-BR | 9 x 7,5 | 24 | 107,00 |



Inyección, N° relieve, blanco masa verde

| Ref. | Medidas | Unidades | Euros |
|---------|---------|----------|--------|
| C-44-BV | 9 x 7,5 | 24 | 107,00 |



Grabado C-42 - C-44

| Ref. | Euros |
|------|-------|
| C-56 | 1,70 |



Nº ruedas - Pescadero normativa

| Ref. | Medidas | Unidades | Euros |
|------|---------|----------|-------|
| C-24 | 13 x 9 | 12 | 50,00 |



Nº ruedas - Pescadero normativa - Con base

| Ref. | Medidas | Unidades | Euros |
|--------|---------|----------|-------|
| C-24-B | 12 x 8 | 12 | 57,00 |



Nº ruedas - Pescadero normativa - Porta-tarjeta

| Ref. | Medidas | Unidades | Euros |
|--------|---------|----------|-------|
| C-24-T | 12 x 8 | 12 | 67,00 |



Pescadería, nº relieve, con base

| Ref. | Medidas | Unidades | Euros |
|-------|-------------|----------|-------|
| C-321 | 13 x 9,5 cm | 12 | 78,00 |



Nº ruedas, con plataforma panadería-pastelería

| Ref. | Medidas | Unidades | Euros |
|------|-----------|----------|-------|
| C-67 | 8,5 x 6,5 | 12 | 32,50 |



Nº ruedas, con plataforma, azul

| Ref. | Medidas | Unidades | Euros |
|---------|-----------|----------|-------|
| C-67-AZ | 8,5 x 6,5 | 12 | 32,50 |



Nº ruedas, con plataforma, rojo

| Ref. | Medidas | Unidades | Euros |
|--------|-----------|----------|-------|
| C-67-R | 8,5 x 6,5 | 12 | 32,50 |



Liso Panadería-Pastelería

| Ref. | Medidas | Unidades | Euros |
|------|---------|----------|-------|
| C-39 | 8,5 x 6 | 12 | 21,00 |



Dorado rectangular

| Ref. | Medidas | Unidades | Euros |
|------|---------|----------|-------|
| C-81 | 6 x 4 | 12 | 11,00 |



Dorado oval

| Ref. | Medidas | Unidades | Euros |
|------|---------|----------|-------|
| C-82 | 5 x 4 | 12 | 11,00 |



Cartel doble cara liso

| Ref. | Medidas | Unidades | Euros |
|-------|---------|----------|-------|
| C-140 | 7 x 6 | 12 | 25,00 |
| C-141 | 12 x 8 | 12 | 32,50 |



Liso pizarra con pincho

| Ref. | Medidas | Unidades | Euros |
|------|--------------|----------|-------|
| C-97 | 8,5 x 6,5 cm | 12 | 17,00 |
| C-98 | 15,5 x 9 cm | 12 | 24,50 |



Liso pizarra sin pincho

| Ref. | Medidas | Unidades | Euros |
|--------|--------------|----------|-------|
| C-97-N | 8,5 x 6,5 cm | 12 | 17,00 |
| C-98-N | 15,5 x 9 cm | 12 | 24,50 |

2 CARTELES PORTAPRECIOS FRUTAS Y VERDURAS

Material: Glaspar - Paleta: Inyección - Ganchos: Acero-Inox - Números : Recambiables - Ruedas



Nº ruedas, 4 dígitos, Paleta

| Ref. | Medidas | Unidades | Euros |
|------|---------|----------|-------|
| C-72 | 18 x 11 | 12 | 59,00 |



Nº ruedas, Paleta

| Ref. | Medidas | Unidades | Euros |
|------|---------|----------|-------|
| C-76 | 22 x 14 | 12 | 57,00 |



Frutas, Nº ruedas, Paleta

| Ref. | Medidas | Euros |
|--------|---------|-------|
| C-76-C | 22 x 14 | 57,00 |



Nº ruedas, 4 dígitos, 2 Ganchos

| Ref. | Medidas | Unidades | Euros |
|------|---------|----------|-------|
| C-73 | 18 x 11 | 12 | 59,00 |



Nº ruedas, Ganchos

| Ref. | Medidas | Unidades | Euros |
|------|---------|----------|-------|
| C-77 | 22 x 14 | 12 | 57,00 |



Frutas, Nº ruedas, Ganchos

| Ref. | Unidades | Euros |
|--------|----------|-------|
| C-77-C | 12 | 57,00 |



Liso pizarra, Paleta

| Ref. | Medidas | Unidades | Euros |
|------|---------|----------|-------|
| C-93 | 19 x 12 | 12 | 39,00 |
| C-95 | 24 x 20 | 12 | 58,00 |

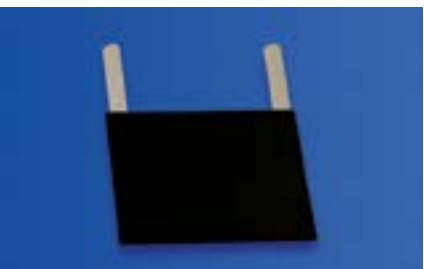

Liso pizarra, Ganchos

| Ref. | Medidas | Unidades | Euros |
|------|---------|----------|-------|
| C-94 | 19 x 12 | 12 | 39,00 |
| C-96 | 24 x 20 | 12 | 58,00 |



Frutas, nº relieve, con ganchos

| Ref. | Medidas | Unidades | Euros |
|-------|-------------|----------|-------|
| C-320 | 13 x 9,5 cm | 12 | 78,00 |



Plataforma con tubo

| Ref. | Altura | Color | Unidades | Euros |
|-------|--------|-------|----------|-------|
| C-1 | 20 cm | ● | 12 | 21,50 |
| C-1-N | 20 cm | ● | 12 | 24,50 |



Pinza para plataforma C-1

| Ref. | Color | Unidades | Euros |
|-------|-------|----------|-------|
| C-1-P | ● | 12 | 11,00 |
| C-1PN | ● | 12 | 13,00 |



Peana

| Ref. | Color | Unidades | Euros |
|-------|-------|----------|-------|
| C-4-B | ● | 12 | 17,00 |
| C-4-M | ● | 12 | 17,00 |



Peana inox. con tubo

| Ref. | Altura | Unidades | Euros |
|-------|--------|----------|-------|
| C-200 | 10 cm | 6 | 45,00 |
| C-201 | 16 cm | 6 | 48,00 |



| Ref. | Altura | Unidades | Euros |
|-------|--------|----------|-------|
| C-205 | 10 cm | 4 | 35,50 |



Pinza para plataforma C-1

| Ref. | Altura | Unidades | Euros |
|-------|--------|----------|-------|
| C-202 | 10 cm | 6 | 50,00 |
| C-203 | 16 cm | 6 | 55,00 |

2 SOPORTES CARTELES INYECCIÓN



Pinza para cubetas

| Ref. | Unidades | Euros |
|------|----------|-------|
| C-9 | 12 | 19,00 |



Pinza plástica

| Ref. | Largo | Unidades | Euros |
|---------|-------|----------|-------|
| C-215-N | 80 mm | 10 | 26,00 |
| C-215-B | 80 mm | 10 | 26,00 |



Peana base redonda
Peana base redonda 8,5cm con soporte.

| Ref. | Unidades | Euros |
|-------|----------|-------|
| C-210 | 10 | 27,00 |



Peana base redonda
Peana base redonda 8,5 cm con soporte 12,5 cm.

| Ref. | Unidades | Euros |
|-------|----------|-------|
| C-211 | 10 | 32,00 |



Pinza abertura máxima
Pinza abertura máxima 3 cm con soporte.

| Ref. | Unidades | Euros |
|-------|----------|-------|
| C-212 | 10 | 33,00 |



Pinza abertura máxima
Pinza abertura máxima 1 con soporte.

| Ref. | Unidades | Euros |
|-------|----------|-------|
| C-213 | 10 | 21,00 |



Pinza abertura máxima
Pinza abertura máxima 1 cm soporte 15 cm.

| Ref. | Unidades | Euros |
|-------|----------|-------|
| C-214 | 10 | 29,00 |



Triángulo dos caras "Peligro suelo mojado". Material ABS amarillo. 62x30 cm

| Ref. | Euros |
|-------|-------|
| C-500 | 19,00 |



Guirnalda perejil

| Ref. | Largo | Euros |
|--------|--------|-------|
| X-2500 | 270 cm | 24,00 |



Hiedra

| Ref. | Largo | Euros |
|--------|--------|-------|
| X-2503 | 270 cm | 32,00 |



Flor de viña

| Ref. | Largo | Euros |
|--------|--------|-------|
| X-2504 | 270 cm | 33,00 |



Rosas rosas

| Ref. | Largo | Euros |
|--------|--------|-------|
| X-2505 | 180 cm | 22,00 |



Navidad

| Ref. | Largo | Euros |
|--------|--------|-------|
| X-2514 | 180 cm | 34,00 |



Guirnalda tomates

| Ref. | Largo | Euros |
|--------|--------|-------|
| X-2800 | 200 cm | 45,00 |



Guirnalda limones

| Ref. | Largo | Euros |
|--------|--------|-------|
| X-2801 | 180 cm | 39,00 |



Guirnalda manzanas

| Ref. | Largo | Euros |
|--------|--------|-------|
| X-2804 | 200 cm | 34,00 |



Guirnalda viña verde

| Ref. | Largo | Euros |
|--------|--------|-------|
| X-2509 | 180 cm | 25,00 |



Separador Perejil base inox

| Ref. | Largo | Unidades | Euros |
|------|-------|----------|-------|
| A-1 | 25 cm | 1 | 15,00 |



Separador Perejil

| Ref. | Largo | Unidades | Euros |
|--------|-------|----------|-------|
| X-0024 | 24 cm | 12 | 82,00 |



Separador rosa roja

| Ref. | Largo | Unidades | Euros |
|--------|-------|----------|-------|
| X-0724 | 24 cm | 12 | 85,00 |



Separador Ciprés verde, base 9,5 x 75

| Ref. | Euros |
|--------|-------|
| X-0100 | 34,00 |



Separador Verde-rojo, base 9,5 x 75

| Ref. | Euros |
|--------|-------|
| X-0101 | 34,00 |



Separador Perejil, base 9,5 x 75

| Ref. | Euros |
|--------|-------|
| X-0102 | 37,00 |

2 SEPARADORES

N



Separador PLEXI GLASS

| Ref. | Medidas | Euros |
|--------|-----------|-------|
| X-9005 | 600 x 200 | 52,00 |
| X-6886 | 800 x 200 | 63,00 |



Separador Blanco 15 x 75

| Ref. | Euros |
|--------|-------|
| X-0200 | 27,00 |



Separador Verde 15 x 75

| Ref. | Euros |
|--------|-------|
| X-0201 | 27,00 |



Separador Transparente 15 x 75

| Ref. | Euros |
|--------|-------|
| X-0202 | 27,00 |



Separador Rojo 15 x 75

| Ref. | Euros |
|--------|-------|
| X-0203 | 27,00 |



Separador Negro 15 x 75

| Ref. | Euros |
|--------|-------|
| X-0204 | 27,00 |

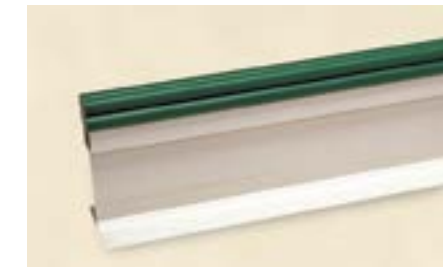

Separador Blanco con adorno verde 7 x 75

| Ref. | Euros |
|--------|-------|
| X-0210 | 25,00 |



Hoja lechuga

| Ref. | Unidades | Euros |
|--------|----------|-------|
| X-2530 | 12 | 30,00 |



Hoja helecho

| Ref. | Unidades | Euros |
|--------|----------|-------|
| X-2515 | 10 | 12,00 |



Mejillones con limones

| Ref. | Euros |
|--------|-------|
| X-2900 | 29,00 |

Bogavante

| Ref. | Euros |
|--------|-------|
| X-2901 | 19,00 |

Cangrejo de mar

| Ref. | Euros |
|--------|-------|
| X-2902 | 31,00 |

Gaviota

| Ref. | Euros |
|--------|-------|
| X-2903 | 34,00 |

Truchas

| Ref. | Euros |
|--------|-------|
| X-2904 | 41,00 |

Estrella de mar - 2 unid.

| Ref. | Euros |
|--------|-------|
| X-2905 | 17,00 |

Conchas 4 unidades

| Ref. | Euros |
|--------|-------|
| X-2906 | 19,50 |

Bolsa con hielo

| Ref. | Euros |
|--------|-------|
| X-2907 | 24,00 |

Red de pesca

| Ref. | Medidas | Euros |
|--------|--------------|-------|
| X-2909 | 200 x 150 cm | 24,00 |



CH12-18 - Barreño industrial sin tap

| Ref. | Medidas | Capacidad | Euros |
|--------------|------------|-----------|--------------|
| CH-12 | 35 x 19 cm | 12 l | 14,50 |
| CH-18 | 39 x 21 cm | 18 l | 19,00 |

Barreño industrial con tapa

| Ref. | Medidas | Capacidad | Euros |
|---------------|------------|-----------|--------------|
| CH-30 | 49 x 26 cm | 30 l | 39,00 |
| CH-40 | 49 x 37 cm | 40 l | 44,00 |
| CH-50 | 49 x 45 cm | 50 l | 48,00 |
| CH-75 | 50 x 60 cm | 75 l | 82,00 |
| CH-100 | 54 x 69 cm | 100 l | 99,00 |

Tapas para barreño industrial

| Ref. | Para referencias | Euros |
|----------------|-----------------------|--------------|
| CHT-50 | CH-30 / CH-40 / CH-50 | 14,75 |
| CHT-75 | CH-75 | 22,50 |
| CHT-100 | CH-100 | 31,50 |

Cubo con medidor 30x29, asa inox., 13L.

| Ref. | Medidas | Capacidad | Euros |
|--------------|------------|-----------|--------------|
| CH-10 | 30 x 29 cm | 13 l | 18,00 |



Cubeta azul pescadería

| Ref. | Medidas | Euros |
|-------|-------------------|-------|
| CC-14 | 60 x 40 x 12,5 cm | 17,50 |



Cubeta encajable con tapa integrada azul Medidas base 50,8 x 33,8

| Ref. | Medidas | Euros |
|-------|-----------------|-------|
| CC-32 | 60 x 40 x 32 cm | 35,50 |



Base rodante para cubetas con 4 ruedas giratorias de poliamida.

| Ref. | Medidas | Carga Máxima | Euros |
|------|------------|--------------|--------|
| R-40 | 60 x 40 cm | 250 KGS | 115,00 |



Cubeta encajables

| Ref. | Medidas | Capacidad | Euros |
|------|-----------------|-----------|-------|
| CH-1 | 26 x 26 x 16 cm | 6 l | 8,00 |
| CH-2 | 30 x 30 x 18 cm | 10 l | 11,00 |
| CH-3 | 34 x 34 x 20 cm | 14 l | 14,50 |
| CH-4 | 30 x 30 x 12 cm | 7,5 l | 9,50 |
| CH-6 | 25 x 18 x 23 cm | 8 l | 8,00 |
| CH-7 | 32 x 29 x 40 cm | 26 l | 18,00 |



Cubetas con asas apilable y encajable

| Ref. | Medidas | Capacidad | Euros |
|--------|---------------------|-----------|-------|
| CC-20 | 65 x 45 x 22,5 cm | 20 l | 38,00 |
| CC-40 | 65 x 45 x 32 cm | 40 l | 46,00 |
| CC-60 | 65 x 45 x 42,5 cm | 60 l | 61,00 |
| CC-100 | 77 x 59,5 x 42,5 cm | 100 l | 75,00 |



Cubeta apilables

| Ref. | Medidas | Capacidad | Euros |
|-------|-----------------------|-----------|-------|
| CC-9 | 60 x 40 x 5,5 cm | 9 l | 15,50 |
| CC-10 | 40 x 30 x 11,8 cm | 11 l | 13,50 |
| CC-12 | 39,5 x 29,5 x 16 cm | 12 l | 19,00 |
| CC-15 | 40 x 30 x 17,5 cm | 16 l | 15,50 |
| CC-16 | 39,5 x 29,5 x 21,5 cm | 15 l | 21,50 |
| CC-19 | 60 x 40 x 9 cm | 19 l | 16,50 |
| CC-21 | 60 x 40 x 11,8 cm | 21 l | 21,50 |
| CC-33 | 60 x 40 x 17 | 33 l | 22,50 |

Tapa

| Ref. | Medidas | Euros |
|--------|----------------|-------|
| CCT-39 | 39,5 x 29,5 cm | 11,00 |
| CCT-40 | 40 x 30 cm | 8,00 |
| CCT-60 | 60 x 40 cm | 15,50 |



BZ-5 / BZ6



Honda

| Ref. | Medidas | Euros |
|-------|--------------------|-------|
| BZ-1 | 33 x 23 x 2,5 cm | 19,50 |
| BZ-2 | 36 x 27 x 2,5 cm | 24,50 |
| BZ-3 | 40 x 30 x 2,5 cm | 27,00 |
| BZ-4 | 51 x 35,5 x 2,5 cm | 34,00 |
| BZ-5 | 30,5 x 16 x 2,5 cm | 18,00 |
| BZ-6 | 46 x 16,5 x 2,5 cm | 19,50 |
| BZ-10 | 58 x 38,5 x 2,5 cm | 53,00 |

Plana

| Ref. | Medidas | Euros |
|-------|--------------|-------|
| BZP-1 | 32 x 22 cm | 19,50 |
| BZP-2 | 35 x 26 cm | 24,50 |
| BZP-3 | 39 x 29 cm | 27,00 |
| BZP-4 | 50 x 34,5 cm | 34,00 |



Honda

| Ref. | Medidas | Euros |
|-------|--------------------|-------|
| BB-1 | 30,5 x 16 x 2,5 cm | 14,50 |
| BB-2 | 16,5 x 46 x 2,5 cm | 17,00 |
| BB-3 | 20 x 27 x 2,5 cm | 16,00 |
| BB-4 | 23 x 33 x 2,5 cm | 18,00 |
| BB-5 | 30 x 40 x 2,5 cm | 24,50 |
| BB-6 | 51 x 35,5 x 2,5 cm | 31,50 |
| BB-9 | 36 x 27 x 2,5 cm | 22,00 |
| BB-10 | 58 x 38,5 x 2,5 cm | 51,00 |

Plana

| Ref. | Medidas | Euros |
|-------|--------------|-------|
| BBP-1 | 26 x 19 cm | 16,00 |
| BBP-2 | 22 x 32 cm | 18,00 |
| BBP-3 | 29 x 39 cm | 24,50 |
| BBP-4 | 50 x 34,5 cm | 31,50 |
| BBP-5 | 35 x 26 cm | 22,00 |

Redonda

| Ref. | Diámetro | Euros |
|------|-----------|-------|
| BB-8 | Ø 24,5 cm | 16,00 |

Cubetita

| Ref. | Medidas | Euros |
|------|----------------------|-------|
| BB-7 | 35,5 x 23,5 x 3,5 cm | 19,00 |



Bandejas acero-inox

| Ref. | Tipo | Medidas | Euros |
|-----------|------|--------------------|-------|
| GI-2/1-20 | 2/1 | 65 x 53 x 2 cm | 45,00 |
| GI-1/1-20 | 1/1 | 53 x 32,5 x 2 cm | 20,00 |
| GI-2/3-20 | 2/3 | 35,5 x 32,5 x 2 cm | 15,50 |
| GI-1/2-20 | 1/2 | 32,5 x 26,5 x 2 cm | 12,00 |
| GI-1/3-20 | 1/3 | 32,5 x 17,5 x 2 cm | 11,00 |
| GI-1/4-20 | 1/4 | 26,4 x 16,2 x 2 cm | 10,00 |



Bandejas Pasteleras Acero Inox. / Aluminio

| Ref. | Medidas | Euros |
|-------|----------------|-------|
| BAC-1 | 60 x 40 x 1 cm | 39,00 |
| BAC-2 | 40 x 30 x 1 cm | 28,00 |

2 CUBETA POR INYECCIÓN-S



Cubetas por inyección-s

| Ref. | Medidas | Capacidad | Euros |
|------|------------------|-----------|-------|
| BC-0 | 30 x 20 x 6 cm | 2 l | 5,00 |
| BC-1 | 34 x 23 x 7 cm | 3 l | 5,60 |
| BC-2 | 43 x 28 x 7,5 cm | 5 l | 8,25 |
| BC-3 | 48 x 33 x 7,8 cm | 8 l | 10,50 |
| BC-4 | 54 x 38 x 8,3 cm | 10 l | 13,00 |
| BC-5 | 60 x 40 x 9 cm | 15 l | 14,50 |

* Otros colores consultar

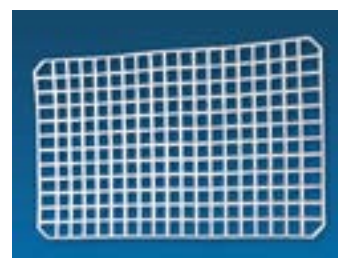

Rejillas blancas para cubetas

| Ref. | Modelo rejillas | Euros |
|-------|-----------------|-------|
| BCR-0 | Para BC-0 | 3,70 |
| BCR-1 | Para BC-1 | 4,00 |
| BCR-2 | Para BC-2 | 4,50 |
| BCR-3 | Para BC-3 | 5,00 |
| BCR-4 | Para BC-4 | 6,00 |

Rejillas blancas para cubetas

| Ref. | Medidas | Euros |
|-------|----------------|-------|
| BCR-5 | 39,5 x 24,7 cm | 13,00 |



Cubetas por inyección-s negras

| Ref. | Medidas | Capacidad | Euros |
|--------|------------------|-----------|-------|
| BC-0-N | 30 x 20 x 6 cm | 2 l | 5,00 |
| BC-1-N | 34 x 23 x 7 cm | 3 l | 5,60 |
| BC-2-N | 43 x 28 x 7,5 cm | 5 l | 8,25 |
| BC-3-N | 48 x 33 x 7,8 cm | 8 l | 10,50 |
| BC-4-N | 54 x 38 x 8,3 cm | 10 l | 13,00 |

Rejillas para cubetas negras adaptables a ref. BC-

| Ref. | Medidas | Euros |
|---------|----------------|-------|
| BCR-5-N | 39,5 x 24,7 cm | 13,00 |



Tapas transparentes

| Ref. | Modelo tapas | Euros |
|-------|--------------|-------|
| BCT-0 | Para BC-0 | 3,70 |
| BCT-1 | Para BC-1 | 4,20 |
| BCT-2 | Para BC-2 | 4,50 |
| BCT-3 | Para BC-3 | 6,50 |





Bandejas por inyección alta presión

| Ref. | Medidas | Euros |
|-------|------------------|-------|
| BI-11 | 29 x 20 x 2 cm | 9,00 |
| BI-12 | 33 x 22,5 x 2 cm | 10,00 |
| BI-13 | 40 x 29 x 2 cm | 12,00 |
| BI-14 | 60 x 40 x 2 cm | 21,00 |



Bandejas ABS para carros R-10/R-20

| Ref. | Medidas | Color | Euros |
|---------|--------------------|-------|-------|
| BI-15-B | 58,5 x 41 x 2,5 cm | ● | 21,00 |
| BI-15-N | 58,5 x 41 x 2,5 cm | ● | 21,00 |
| BI-15-R | 58,5 x 41 x 2,5 cm | ● | 21,00 |

BANDEJAS POR INYECCIÓN BAJA PRESIÓN



Bandejas por inyección baja presión

| Ref. | Medidas | Euros |
|-------|------------------|-------|
| BI-21 | 29 x 20 x 2 cm | 5,00 |
| BI-22 | 33 x 22,5 x 2 cm | 5,60 |
| BI-23 | 40 x 29 x 2 cm | 8,25 |



Bandejas por inyección presión negra

| Ref. | Medidas | Euros |
|---------|------------------|-------|
| BI-21-N | 29 x 20 x 2 cm | 5,00 |
| BI-22-N | 33 x 22,5 x 2 cm | 5,60 |
| BI-23-N | 40 x 29 x 2 cm | 8,25 |



Cubetas gastronorm policarbonato. Temperatura - 40° + 110°



| Ref. | Tipo | Medidas | | Euros |
|------------|------|----------------------|-------|-------|
| GP-2/1-200 | 2/1 | 65 x 53 x 20 cm | | 53,00 |
| GP-1/1-65 | 1/1 | 53 x 32,5 x 6,5 cm | | 16,00 |
| GP-1/1-100 | 1/1 | 53 x 32,5 x 10 cm | | 21,00 |
| GP-1/1-150 | 1/1 | 53 x 32,5 x 15 cm | | 22,50 |
| GP-1/1-200 | 1/1 | 53 x 32,5 x 20 cm | | 29,00 |
| GP-1/2-65 | 1/2 | 32,5 x 26,5 x 6,5 cm | | 9,00 |
| GP-1/2-100 | 1/2 | 32,5 x 26,5 x 10 cm | | 10,00 |
| GP-1/2-150 | 1/2 | 32,5 x 26,5 x 15 cm | | 13,50 |
| GP-1/2-200 | 1/2 | 32,5 x 26,5 x 20 cm | 15,00 | |
| GP-1/3-65 | 1/3 | 32,5 x 17,5 x 6,5 cm | | 7,00 |
| GP-1/3-100 | 1/3 | 32,5 x 17,5 x 10 cm | | 8,50 |
| GP-1/3-150 | 1/3 | 32,5 x 17,5 x 15 cm | | 10,50 |
| GP-1/3-200 | 1/3 | 32,5 x 17,5 x 20 cm | 13,00 | |
| GP-1/4-65 | 1/4 | 26,4 x 16,2 x 6,5 cm | | 6,00 |
| GP-1/4-100 | 1/4 | 26,4 x 16,2 x 10 cm | | 7,00 |
| GP-1/4-150 | 1/4 | 26,4 x 16,2 x 15 cm | | 8,00 |
| GP-1/4-200 | 1/4 | 26,4 x 16,2 x 20 cm | | 10,00 |
| GP-1/6-65 | 1/6 | 17,6 x 16,2 x 6,5 cm | | 4,00 |
| GP-1/6-100 | 1/6 | 17,6 x 16,2 x 10 cm | | 5,00 |
| GP-1/6-150 | 1/6 | 17,6 x 16,2 x 15 cm | | 7,00 |
| GP-1/6-200 | 1/6 | 17,6 x 16,2 x 20 cm | 8,00 | |
| GP-1/9-65 | 1/9 | 17,6 x 10,8 x 6,5 cm | | 3,00 |
| GP-1/9-100 | 1/9 | 17,6 x 10,8 x 10 cm | | 4,00 |
| | | | | |



Tapas policarbonato

| Ref. | Tipo | Medidas | Euros |
|---------|------|----------------|-------|
| GPT 2/1 | 2/1 | 65 x 53 cm | 33,00 |
| GPT 1/1 | 1/1 | 53 x 32,5 cm | 13,00 |
| GPT 1/2 | 1/2 | 32,5 x 26,5 cm | 7,00 |
| GPT 1/3 | 1/3 | 32,5 x 17,5 cm | 5,50 |
| GPT 1/4 | 1/4 | 26,4 x 16,2 cm | 4,50 |
| GPT 1/6 | 1/6 | 17,6 x 16,2 cm | 3,50 |
| GPT 1/9 | 1/9 | 17,6 x 10,8 cm | 3,00 |

Doble fondo perforado policarbonato

| Ref. | Tipo | Medidas | Euros |
|----------|------|----------------|-------|
| GPFP-2/1 | 2/1 | 56,5 x 44,5 cm | 19,00 |
| GPFP-1/1 | 1/1 | 46,5 x 26,5 cm | 8,50 |
| GPFP-1/2 | 1/2 | 26,5 x 20,5 cm | 4,50 |



Cubetas gastronorm acero inoxidable. AISI 304 18/10



| Ref. | Tipo | Medidas | | Euros |
|------------|------|----------------------|--|--------|
| GI-2/1-20 | 2/1 | 65 x 53 x 2 cm | | 45,00 |
| GI-2/1-40 | 2/1 | 65 x 53 x 4 cm | | 47,00 |
| GI-2/1-65 | 2/1 | 65 x 53 x 6,5 cm | | 54,00 |
| GI-2/1-100 | 2/1 | 65 x 53 x 10 cm | | 63,00 |
| GI-2/1-150 | 2/1 | 65 x 53 x 15 cm | | 94,00 |
| GI-2/1-200 | 2/1 | 65 x 53 x 20 cm | | 105,00 |
| GI-1/1-20 | 1/1 | 53 x 32,5 x 2 cm | | 20,00 |
| GI-1/1-40 | 1/1 | 53 x 32,5 x 4 cm | | 23,00 |
| GI-1/1-65 | 1/1 | 53 x 32,5 x 6,5 cm | | 26,00 |
| GI-1/1-100 | 1/1 | 53 x 32,5 x 10 cm | | 32,00 |
| GI-1/1-150 | 1/1 | 53 x 32,5 x 15 cm | | 39,00 |
| GI-1/1-200 | 1/1 | 53 x 32,5 x 20 cm | | 57,00 |
| GI-2/3-20 | 2/3 | 35,5 x 32,5 x 2 cm | | 15,50 |
| GI-2/3-40 | 2/3 | 35,5 x 32,5 x 4 cm | | 17,50 |
| GI-2/3-65 | 2/3 | 35,5 x 32,5 x 6,5 cm | | 19,00 |
| GI-2/3-100 | 2/3 | 35,5 x 32,5 x 10 cm | | 24,00 |
| GI-2/3-150 | 2/3 | 35,5 x 32,5 x 15 cm | | 41,00 |
| GI-2/3-200 | 2/3 | 35,5 x 32,5 x 20 cm | | 47,00 |

Cubetas gastronorm acero inoxidable. AISI 304 18/10



| Ref. | Tipo | Medidas | | Euros |
|------------|------|----------------------|--|-------|
| GI-1/2-20 | 1/2 | 32,5 x 26,5 x 2 cm | | 12,00 |
| GI-1/2-40 | 1/2 | 32,5 x 26,5 x 4 cm | | 14,00 |
| GI-1/2-65 | 1/2 | 32,5 x 26,5 x 6,5 cm | | 16,00 |
| GI-1/2-100 | 1/2 | 32,5 x 26,5 x 10 cm | | 19,00 |
| GI-1/2-150 | 1/2 | 32,5 x 26,5 x 15 cm | | 25,00 |
| GI-1/2-200 | 1/2 | 32,5 x 26,5 x 20 cm | | 37,00 |
| GI-1/3-20 | 1/3 | 32,5 x 17,5 x 2 cm | | 11,00 |
| GI-1/3-40 | 1/3 | 32,5 x 17,5 x 4 cm | | 12,50 |
| GI-1/3-65 | 1/3 | 32,5 x 17,5 x 6,5 cm | | 13,50 |
| GI-1/3-100 | 1/3 | 32,5 x 17,5 x 10 cm | | 16,00 |
| GI-1/3-150 | 1/3 | 32,5 x 17,5 x 15 cm | | 20,00 |
| GI-1/3-200 | 1/3 | 32,5 x 17,5 x 20 cm | | 31,00 |
| GI-1/4-20 | 1/4 | 26,4 x 16,2 x 2 cm | | 10,00 |
| GI-1/4-40 | 1/4 | 26,4 x 16,2 x 4 cm | | 12,00 |
| GI-1/4-65 | 1/4 | 26,4 x 16,2 x 6,5 cm | | 13,00 |
| GI-1/4-100 | 1/4 | 26,4 x 16,2 x 10 cm | | 15,00 |
| GI-1/4-150 | 1/4 | 26,4 x 16,2 x 15 cm | | 21,00 |
| GI-1/4-200 | 1/4 | 26,4 x 16,2 x 20 cm | | 27,00 |



| | | | | |
|------------|-----|----------------------|--|-------|
| GI-1/6-65 | 1/6 | 17,6 x 16,2 x 6,5 cm | | 11,00 |
| GI-1/6-100 | 1/6 | 17,6 x 16,2 x 10 cm | | 13,00 |
| GI-1/6-150 | 1/6 | 17,6 x 16,2 x 15 cm | | 18,00 |
| GI-1/6-200 | 1/6 | 17,6 x 16,2 x 20 cm | | 29,00 |
| GI-1/9-65 | 1/9 | 17,6 x 10,8 x 6,5 cm | | 10,00 |
| GI-1/9-100 | 1/9 | 17,6 x 10,8 x 10 cm | | 12,00 |

2 CUBETAS GASTRONORM ACERO INDOXIDABLE



Cubetas gastronorm perforadas acero inoxidable

| Ref. | Tipo | Medidas | Euros |
|-------------|------|----------------------|-------|
| GIP-2/1-20 | 2/1 | 65 x 53 x 2 cm | 57,00 |
| GIP-2/1-40 | 2/1 | 65 x 53 x 4 cm | 59,00 |
| GIP-2/1-65 | 2/1 | 65 x 53 x 6,5 cm | 64,00 |
| GIP-1/1-20 | 1/1 | 53 x 32,5 x 2 cm | 23,00 |
| GIP-1/1-40 | 1/1 | 53 x 32,5 x 4 cm | 26,00 |
| GIP-1/1-65 | 1/1 | 53 x 32,5 x 6,5 cm | 24,50 |
| GIP-1/1-100 | 1/1 | 53 x 32,5 x 10 cm | 38,00 |
| GIP-1/1-150 | 1/1 | 53 x 32,5 x 15 cm | 61,00 |
| GIP-1/1-200 | 1/1 | 53 x 32,5 x 20 cm | 74,00 |
| GIP-1/2-65 | 1/2 | 32,5 x 26,5 x 6,5 cm | 17,00 |
| GIP-1/2-100 | 1/2 | 32,5 x 26,5 x 10 cm | 23,00 |
| GIP-1/2-150 | 1/2 | 32,5 x 26,5 x 15 cm | 38,00 |
| GIP-1/2-200 | 1/2 | 32,5 x 26,5 x 20 cm | 47,00 |

Tapas de cubierta gastronorm acero inox.

| Ref. | Tipo | Medidas | Euros |
|---------|------|----------------|-------|
| GIT-1/1 | 1/1 | 53 x 32,5 cm | 21,00 |
| GIT-2/3 | 2/3 | 35,5 x 32,5 cm | 14,00 |
| GIT-1/2 | 1/2 | 32,5 x 26,5 cm | 12,00 |
| GIT-1/3 | 1/3 | 32,5 x 17,5 cm | 10,00 |
| GIT-1/4 | 1/4 | 26,4 x 16,2 cm | 9,00 |
| GIT-1/6 | 1/6 | 17,6 x 16,2 cm | 8,00 |
| GIT-1/9 | 1/9 | 17,6 x 10,8 cm | 7,00 |

Tapas acero inoxidable hermética

| Ref. | Tipo | Medidas | Euros |
|----------|------|----------------|-------|
| GITH-1/1 | 1/1 | 53 x 32,5 cm | 63,00 |
| GITH-2/3 | 2/3 | 35,5 x 32,5 cm | 45,00 |
| GITH-1/2 | 1/2 | 32,5 x 26,5 cm | 43,00 |
| GITH-1/3 | 1/3 | 32,5 x 17,5 cm | 32,00 |
| GITH-1/4 | 1/4 | 26,4 x 16,2 cm | 27,00 |
| GITH-1/6 | 1/6 | 17,6 x 16,2 cm | 25,00 |

CUBETAS GASTRONORM ACERO INDOXIDABLE

Doble fondo perforado acero inoxidable

| Ref. | Tipo | Medidas | Euros |
|----------|------|----------------|-------|
| GIFP-2/1 | 2/1 | 59 x 47 cm | 48,00 |
| GIFP-1/1 | 1/1 | 47 x 27 cm | 27,00 |
| GIFP-2/3 | 2/3 | 29,5 x 26,5 cm | 21,00 |
| GIFP-1/2 | 1/2 | 26,5 x 20,5 cm | 19,00 |

Separadores acero inoxidable

| Ref. | Tipo | Medidas | Euros |
|---------|------|-------------|-------|
| GIS-530 | 1/1 | 53 x 2 cm | 12,00 |
| GIS-325 | 1/2 | 32,5 x 2 cm | 9,00 |



Metacrilato acrílico. Apto lavavajillas. No apto para horno-microondas

System gastronorm, negro. Temperatura - 20° + 80°

| Ref. | Tipo | Medidas | Euros |
|----------------|------|----------------------|-------|
| BP-GN-1/1-17-N | 1/1 | 53 x 32,5 x 1,7 cm | 57,00 |
| BP-GN 1/1-50-N | 1/1 | 53 x 32,5 x 5 cm | 64,00 |
| BP-GN-1/2-17-N | 1/2 | 32,5 x 26,5 x 1,7 cm | 24,00 |
| BP-GN 1/2-50-N | 1/2 | 32,5 x 26,5 x 5 cm | 33,50 |
| BP-GN 1/3-17-N | 1/3 | 32,5 x 17,6 x 1,7 cm | 18,50 |
| BP-GN 1/3-50-N | 1/3 | 32,5 x 17,6 x 5 cm | 25,00 |
| BP-GN 1/4-17-N | 1/4 | 26,5 x 16,2 x 1,7 cm | 16,00 |
| BP-GN 1/4-50-N | 1/4 | 26,5 x 16,2 x 5 cm | 21,00 |
| BP-GN 1/5-17-N | 1/5 | 26,5 x 20 x 1,7 cm | 17,00 |
| BP-GN 1/5-50-N | 1/5 | 26,5 x 20 x 5 cm | 21,00 |
| BP-GN 1/6-50-N | 1/6 | 17,6 x 16,2 x 5 cm | 18,50 |
| BP-GN 1/9-50-N | 1/9 | 17,6 x 10,8 x 5 cm | 16,00 |
| BP-GN 2/4-17-N | 2/4 | 53 x 16,2 x 1,7 cm | 31,00 |
| BP-GN 2/5-17-N | 2/5 | 53 x 20 x 1,7 cm | 33,00 |
| BP-GN 3/4-17-N | 3/4 | 48,7 x 26,5 x 1,7 cm | 35,00 |
| BP-GN 3/4-50-N | 3/4 | 48,7 x 26,5 x 5 cm | 43,00 |
| BP-GN 5/4-40-N | 5/4 | 81 x 26,5 x 4 cm | 77,00 |



Tapas transparente

| Ref. | Tipo | Medidas | Euros |
|-----------|------|----------------|-------|
| BPT-1/1-T | 1/1 | 53 x 32,5 cm | 46,00 |
| BPT-1/2-T | 1/2 | 32,5 x 26,5 cm | 29,00 |
| BPT-1/3-T | 1/3 | 32,5 x 17,6 cm | 28,00 |
| BPT-1/4-T | 1/4 | 26,5 x 16,2 cm | 21,00 |
| BPT-1/5-T | 1/5 | 26,5 x 20 cm | 28,00 |
| BPT-2/5-T | 2/5 | 53 x 20 cm | 36,00 |
| BPT-3/4-T | 3/4 | 48,7 x 26,5 cm | 40,00 |



Rejillas negro

| Ref. | Tipo | Medidas | Euros |
|-----------|------|--------------------|-------|
| BPR-1/1-N | 1/1 | 53 x 32,5 cm | 59,50 |
| BPR-1/2-N | 1/2 | 32,5 x 26,5 cm | 30,00 |
| BPR-1/3-N | 1/3 | 32,5 x 17,6 x 8 cm | 21,00 |
| BPR-1/4-N | 1/4 | 26,5 x 16,2 cm | 20,00 |
| BPR-1/5-N | 1/5 | 26,5 x 20 cm | 24,00 |



Triángulo

| Ref. | Medidas | Altura | Euros |
|--------------|-------------------|--------|-------|
| BPTR-27-20-N | 27 x 27 x 37 cm | 2 cm | 21,00 |
| BPTR-40-20-N | 40 x 40 x 56,5 cm | 2 cm | 33,00 |
| BPTR-40-50-N | 40 x 40 x 56,5 cm | 5 cm | 38,00 |





9 Bandejas + escalera

Temperatura - 20° + 80°



x1



x2

Escalera anfiteatro

| Ref. | Medidas | Euros |
|----------|------------------|--------|
| BPA-ANFI | 80 x 80 x 6,5 cm | 350,00 |

1/4 luna 90° negro

| Ref. | Medidas | Euros |
|-------------|--------------------|-------|
| BPA-90-50-N | 26,5 x 26,5 x 5 cm | 36,00 |

Esquina 45° negro

| Ref. | Tipo | Euros |
|-------------|-----------------------|-------|
| BPA-45-50-N | 39/22 x 26,5 x 5,0 cm | 45,00 |



x4



x1



x1

Esquina 22,5° negro

| Ref. | Tipo | Euros |
|--------------|-----------------------|-------|
| BPA-22G-50-N | 30/21 x 26,0 x 5,0 cm | 32,00 |

Triángulo izquierdo negro

| Ref. | Tipo | Euros |
|-------------|------------------|-------|
| BPA-TI-50-N | 53 x 30 x 5,0 cm | 40,00 |

Triángulo derecho negro

| Ref. | Tipo | Euros |
|-------------|------------------|-------|
| BPA-TD-50-N | 53 x 30 x 5,0 cm | 40,00 |

13 Bandejas + escalera

Temperatura - 20° + 80°



Escalera anfiteatro

| Ref. | Medidas | Euros |
|----------|------------------|--------|
| BPA-ANFI | 80 x 80 x 6,5 cm | 350,00 |



x1

1/4 luna 90° negro

| Ref. | Medidas | Euros |
|-------------|--------------------|-------|
| BPA-90-50-N | 26,5 x 26,5 x 5 cm | 36,00 |



x4

Esquina 22,5° negro

| Ref. | Tipo | Euros |
|--------------|-----------------------|-------|
| BPA-22P-50-N | 20/11 x 26,5 x 5,0 cm | 24,00 |



x6

Esquina 15° negro

| Ref. | Tipo | Euros |
|-------------|-----------------------|-------|
| BPA-15-50-N | 20/14 x 26,5 x 5,0 cm | 22,00 |



x1

Triángulo izquierdo negro

| Ref. | Tipo | Euros |
|-------------|------------------|-------|
| BPA-TI-50-N | 53 x 30 x 5,0 cm | 40,00 |



x1

Triángulo derecho negro

| Ref. | Tipo | Euros |
|-------------|------------------|-------|
| BPA-TD-50-N | 53 x 30 x 5,0 cm | 40,00 |



Oval 420 x 270 mm H30

| Ref. | Medidas | Euros |
|------------|----------------|-------|
| BP-10063-N | 42 x 27 x 3 cm | 45,00 |



Octo 265 x 200 mm H50 GN1/5

| Ref. | Medidas | Euros |
|-----------|------------------|-------|
| BP-6960-N | 26,5 x 20 x 5 cm | 26,00 |



Octo 265 x 325 mm H45 GN1/2

| Ref. | Medidas | Euros |
|-----------|----------------------|-------|
| BP-5355-N | 26,5 x 32,5 x 4,5 cm | 38,00 |



Oval 265 x 200 mm H 65 mm GN1/5

| Ref. | Medidas | Euros |
|-----------|--------------------|-------|
| BP-6665-N | 26,5 x 20 x 6,5 cm | 27,00 |



Oval 265 x 325 mm H 65 mm GN1/2

| Ref. | Medidas | Euros |
|-----------|----------------------|-------|
| BP-6661-N | 26,5 x 32,5 x 6,5 cm | 35,00 |



Redonda Ø 300 mm H 65 mm

| Ref. | Altura | Diámetro | Euros |
|-----------|--------|----------|-------|
| BP-6670-N | 6,5 cm | Ø 30 cm | 40,00 |



Redonda/Exa 175 mm H 80 mm 1,5l

| Ref. | Altura | Diámetro | Euros |
|-----------|--------|-----------|-------|
| BP-4013-N | 8 cm | Ø 17,5 cm | 27,00 |



Redonda/Exa 215 mm H 80 mm 2,5l

| Ref. | Altura | Diámetro | Euros |
|-----------|--------|-----------|-------|
| BP-6675-N | 8 cm | Ø 21,5 cm | 33,00 |



Tapa Plexiline redonda/hexa transparente

| Ref. | Diámetro | Para | Euros |
|----------|----------|----------------|-------|
| BPT-4015 | Ø 175 | Ref. BP-4013-N | 11,00 |
| BPT-6680 | Ø 215 | Ref. BP-6675-N | 14,00 |



Base 8 x 1,5l Redonda/Exa. HIPS 800x400 mm H 80 mm. Para ref. BP-4013-N.

| Ref. | Medidas | Euros |
|-----------|----------------|--------|
| BPB-25140 | 80 x 40 x 8 cm | 195,00 |



Cubeta concha 270x250 mm H 70 mm

| Ref. | Medidas | Euros |
|-----------|----------------|-------|
| BP-5356-N | 27 x 25 x 7 cm | 39,00 |



Cubeta Huevo 300x210 mm H 75 mm

| Ref. | Medidas | Euros |
|-----------|------------------|-------|
| BP-5921-N | 30 x 21 x 7,5 cm | 45,00 |



Yin Yang 300 mm H 65 mm

| Ref. | Altura | Diámetro | Euros |
|-----------|--------|----------|-------|
| BP-5869-N | 6,5 cm | Ø 30 cm | 29,00 |



Pala de picar

| Ref. | Largo | Euros |
|-----------|--------|-------|
| BP-1946-N | 260 mm | 12,00 |



Cuchara

| Ref. | Largo | Euros |
|-----------|--------|-------|
| BP-6901-N | 240 mm | 5,50 |



Cuchara perforadora

| Ref. | Largo | Euros |
|------------|--------|-------|
| BP-14330-N | 250 mm | 6,50 |



Expositor de sandwich

| Ref. | Medidas | Euros |
|-----------|-------------------|-------|
| BP-9327-N | 520 x 135 x 50 mm | 39,00 |



Pinza plástica

| Ref. | Largo | Unidades | Euros |
|---------|-------|----------|-------|
| C-215-N | 80 mm | 10 | 26,00 |
| C-215-B | 80 mm | 10 | 26,00 |



Escalón 3 niveles 500x800 mm H 80 mm

| Ref. | Medidas | Euros |
|-------------------|-------------------|---------------|
| BPB-9232-N | 500 x 800 x 80 mm | 199,00 |



Escalón 3 niveles 250x800 mm H 80 mm

| Ref. | Medidas | Euros |
|--------------------|-------------------|---------------|
| BPB-10569-N | 250 x 800 x 80 mm | 150,00 |



Escalón 1 nivel 624x280 mm H 75 mm

| Ref. | Medidas | Euros |
|--------------------|-------------------|--------------|
| BPB-17068-N | 624 x 280 x 75 mm | 98,00 |



Escalón 1 nivel 624x280 mm H 35 mm

| Ref. | Medidas | Euros |
|--------------------|-------------------|--------------|
| BPB-17069-N | 624 x 280 x 35 mm | 85,00 |



Escalón 1 nivel 312x280 mm H 75 mm

| Ref. | Medidas | Euros |
|--------------------|-------------------|--------------|
| BPB-17071-N | 312 x 280 x 75 mm | 50,00 |



Escalón 1 nivel 312x280 mm H 35 mm

| Ref. | Medidas | Euros |
|--------------------|-------------------|--------------|
| BPB-17070-N | 312 x 280 x 35 mm | 43,00 |



Base giratoria 80 cm

| Ref. | Altura | Diámetro | Euros |
|-------------|--------|----------|--------|
| BPC-24544-N | 5 mm | Ø 800 mm | 430,00 |



x4

Triángulo

| Ref. | Medidas | Euros |
|-------------|-------------------|-------|
| BPC-22861-N | 325 x 158 x 60 mm | 25,00 |



x1

Ensaladera Redonda 2,5l

| Ref. | Altura | Diámetro | Euros |
|-------------|--------|----------|-------|
| BPC-22866-N | 80 mm | Ø 225 mm | 33,00 |



x8

GN 1/5 265x265 mm

| Ref. | Medidas | Euros |
|-------------|-------------------|-------|
| BPC-22860-N | 265 x 265 x 80 mm | 33,00 |







3

Picadoras

Empujadores picadoras

Cuchillas y placas picadoras

Cintas de sierra

Cortadoras

Ralladoras

Exprimidor cítricos

Cortadora multifunción

Cutters

Molino

Afiladoras



Picadora de carne
 Boca: 12.
 Cuerpo acero inoxidable.
 Grupo picador: acero inoxidable.
 Cuchilla autoafilante.
 Interruptor: invertidor de marcha.
 Potencia: 1 HP.
 Motor: monofásico 220 V.
 Producción: 120 kg/h

| Ref. | Peso | Euros |
|------------|-------|---------|
| MP-12MEC-M | 23 kg | 1399,00 |

Picadora de carne
 Boca 12.
 Cuerpo: acero inoxidable.
 Grupo picador: acero inoxidable.
 Cuchilla autoafilante.
 Interruptor: invertidor de marcha.
 Potencia 1 HP.
 Motor: trifásico 220/380 V.
 V. Producción: 120 kg/h

| Ref. | Peso | Euros |
|------------|-------|---------|
| MP-12MEC-T | 23 kg | 1350,00 |

Despiece

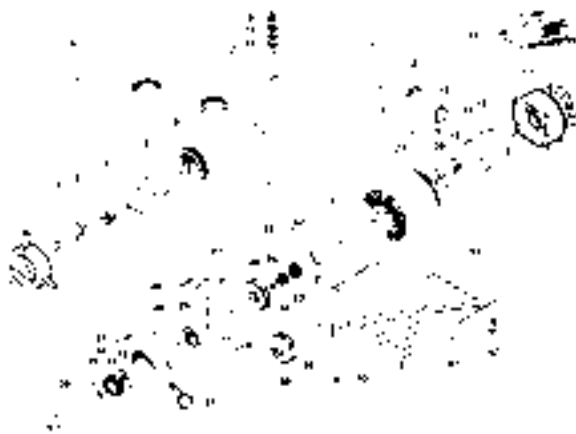

Medidas

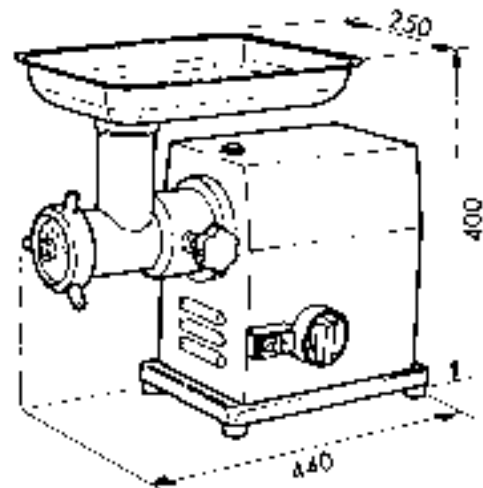



Picadora de carne
 Boca: 22.
 Cuerpo: acero inoxidable.
 Grupo picador: acero inoxidable.
 Cuchilla: autoafilante.
 Interruptor: invertidor de marcha.
 Potencia: 1 HP.
 Motor: monofásico 220 V.
 Producción: 130 kg/h

| Ref. | Peso | Euros |
|--------------|-------|---------|
| MP-22 EURO-M | 23 kg | 1600,00 |

Picadora de carne
 Boca: 22.
 Cuerpo: acero inoxidable.
 Grupo picador: acero inoxidable.
 Cuchilla: autoafilante.
 Interruptor: invertidor de marcha.
 Potencia: 1 HP.
 Motor: trifásico 220/380 V.
 Producción: 130 kg/h

| Ref. | Peso | Euros |
|--------------|-------|---------|
| MP-22 EURO-T | 23 kg | 1555,00 |

Despiece



Medidas

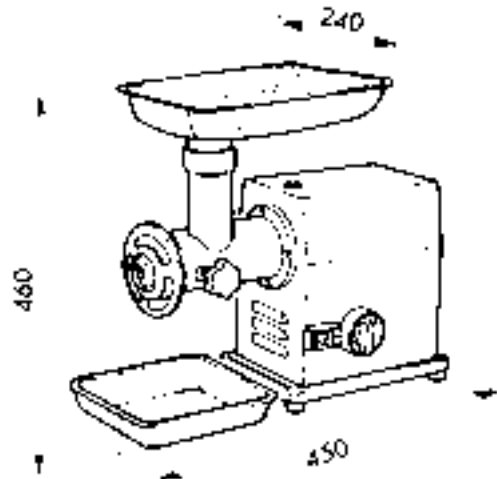



Picadora de carne
 Boca: 22.
 Cuerpo: acero inoxidable.
 Grupo picador: acero inoxidable.
 Cuchilla: autoafilante.
 Interruptor: invertidor de marcha.
 Potencia: 1,5 HP.
 Motor: monofásico 220 V.
 Producción 250 kg/h

| Ref. | Peso | Euros |
|------------|-------|---------|
| MP22 MEC-M | 30 kg | 2010,00 |

Picadora de carne
 Boca: 22.
 Cuerpo: acero inoxidable.
 Grupo picador: acero inoxidable.
 Cuchilla: autoafilante.
 Interruptor: invertidor de marcha.
 Potencia: 1,5 HP.
 Motor: trifásico 220/380V.
 Producción 250 kg/h

| Ref. | Peso | Euros |
|-------------|-------|---------|
| MP-22 MEC-T | 30 kg | 1945,00 |

Despiece



Medidas

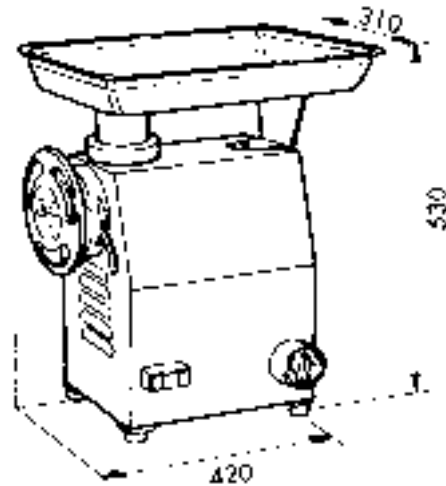



Picadora de carne
 Boca: 32.
 Cuerpo: acero inoxidable.
 Grupo picador: acero inoxidable.
 Cuchilla: autoafilante.
 Interruptor: invertidor de marcha.
 Potencia 2,5 HP.
 Motor monofásico 220 V.
 Producción: 500 kg/h.

| Ref. | Peso | Euros |
|-------------|-------|---------|
| MP-32 MEC-M | 47 kg | 2860,00 |

Picadora de carne
 Boca: 32.
 Cuerpo: acero inoxidable.
 Grupo picador: acero inoxidable.
 Cuchilla: autoafilante.
 Interruptor: invertidor de marcha.
 Potencia 3 HP.
 Motor trifásico 220/380 V.
 Producción: 500 kg/h.

| Ref. | Peso | Euros |
|-------------|-------|---------|
| MP-32 MEC-T | 47 kg | 2700,00 |

Despiece

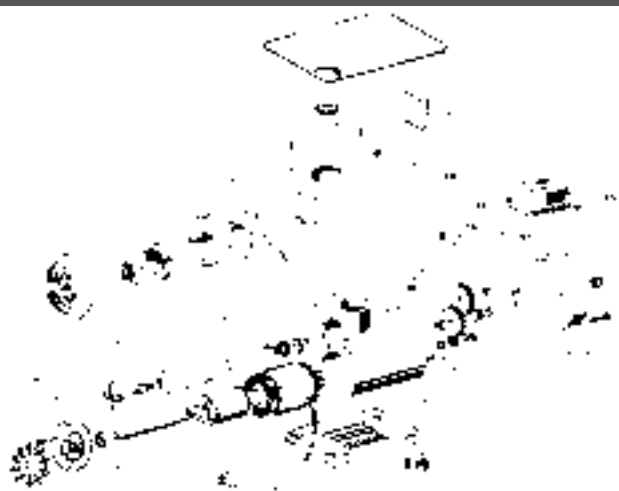

Medidas

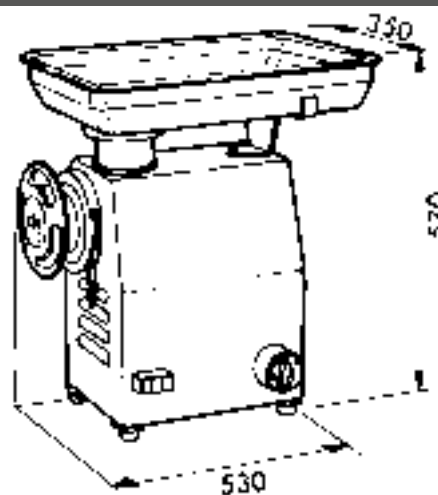

3 PICADORA REFRIGERADA C.G.T.



Picadora refrigerada
 Boca: 22.
 Cuerpo: acero inoxidable.
 Grupo picador: acero inoxidable.
 Cuchilla: autoafilante.
 Interruptor: invertidor de marcha.
 Potencia 1,5 HP.
 Grupo refrigerador hermético ventilado.
 Motor trifásico 220/380 V.
 Peso: 58 kg.
 Producción: 200 kg/h.

| Ref. | Euros |
|-----------|---------|
| MP-22RE-T | 4300,00 |

Picadora refrigerada
 Boca: 32.
 Cuerpo: acero inoxidable.
 Grupo picador: acero inoxidable.
 Cuchilla: autoafilante.
 Interruptor: invertidor de marcha.
 Potencia 3 HP.
 Grupo refrigerador hermético ventilado.
 Motor trifásico 220/380 V.
 Peso: 80 kg.
 Producción: 300 kg/h.

| Ref. | Euros |
|-----------|---------|
| MP-32RE-T | 5300,00 |

Despiece



Medidas

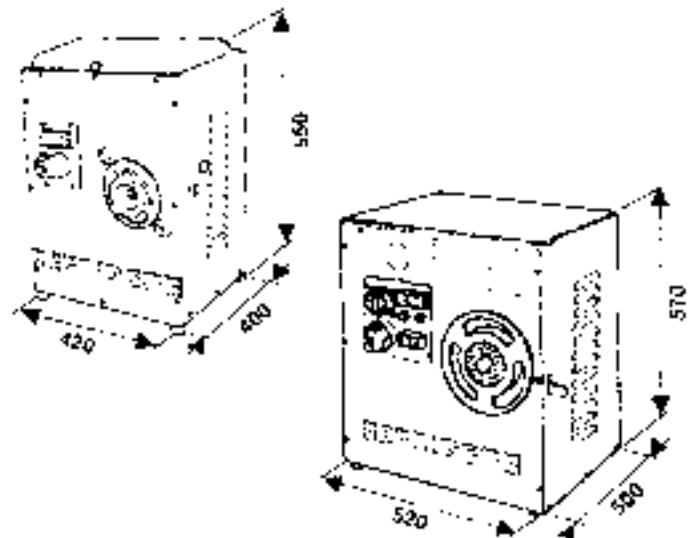



Picadora inox monofase
Boca: 8.
Cuerpo: acero inoxidable.
Grupo picador: acero inoxidable.
Cuchilla autoafilante.
Motor ventilado.
Potencia 0,5 HP.
Producción: 70 kg/h.

| Ref. | Voltaje (V) | Medidas | Peso | Euros |
|--------|-------------|-------------------|------|--------|
| MP-8-M | 220 | 27,5 x 25 x 35 cm | 9 kg | 495,00 |

Despiece



EMPUJADORES PICADORAS



Empujador picadoras inyección

| Ref. | Diámetro | Largo | Euros |
|---------|----------|---------|-------|
| A-35-13 | Ø 5 cm | 13 cm | 14,50 |
| A-35-15 | Ø 5 cm | 15 cm | 14,50 |
| A-35-26 | Ø 4,5 cm | 12,5 cm | 14,50 |



Empujador picadoras polietileno

| Ref. | Diámetro | Largo | Euros |
|---------|----------|-------|-------|
| A-36-11 | Ø 5 cm | 11 cm | 40,00 |
| A-36-13 | Ø 5 cm | 13 cm | 43,00 |
| A-36-15 | Ø 5 cm | 15 cm | 48,00 |



Cuchilla inox

| | Ref. | Euros |
|------------------|-------|-------|
| Cuchilla inox 8 | CP-8 | 17,00 |
| Cuchilla inox 12 | CP-12 | 13,00 |
| Cuchilla inox 22 | CP-22 | 16,00 |
| Cuchilla inox 32 | CP-32 | 18,00 |



Placa inox 8

| Ref. | Diámetro | Euros 1 chaveta | Euros 2 chavetas |
|----------|----------|-----------------|------------------|
| CP-8-3 | Ø 3 mm | 18,00 | 27,00 |
| CP-8-3,5 | Ø 3,5 mm | 16,00 | 25,00 |
| CP-8-4 | Ø 4 mm | 14,00 | 23,00 |
| CP-8-4,5 | Ø 4,5 mm | 14,00 | 23,00 |
| CP-8-5 | Ø 5 mm | 13,00 | 22,00 |
| CP-8-6 | Ø 6 mm | 13,00 | 22,00 |
| CP-8-7 | Ø 7 mm | 13,00 | 22,00 |
| CP-8-8 | Ø 8 mm | 13,00 | 22,00 |

Placa inox 12

| Ref. | Diámetro | Euros 1 chaveta | Euros 2 chavetas |
|-----------|----------|-----------------|------------------|
| CP-12-3 | Ø 3 mm | 24,00 | 33,00 |
| CP-12-3,5 | Ø 3,5 mm | 22,00 | 31,00 |
| CP-12-4 | Ø 4 mm | 18,50 | 27,50 |
| CP-12-4,5 | Ø 4,5 mm | 18,50 | 27,50 |
| CP-12-5 | Ø 5 mm | 17,50 | 26,50 |
| CP-12-6 | Ø 6 mm | 17,50 | 26,50 |
| CP-12-7 | Ø 7 mm | 17,50 | 26,50 |
| CP-12-8 | Ø 8 mm | 17,00 | 26,00 |

Placa inox 22

| Ref. | Diámetro | Euros 1 chaveta | Euros 2 chavetas |
|-----------|----------|-----------------|------------------|
| CP-22-3 | Ø 3 mm | 30,00 | 39,00 |
| CP-22-3,5 | Ø 3,5 mm | 28,50 | 37,50 |
| CP-22-4 | Ø 4 mm | 23,00 | 32,00 |
| CP-22-4,5 | Ø 4,5 mm | 23,00 | 32,00 |
| CP-22-5 | Ø 5 mm | 22,50 | 31,50 |
| CP-22-6 | Ø 6 mm | 22,50 | 31,50 |
| CP-22-7 | Ø 7 mm | 22,00 | 31,00 |
| CP-22-8 | Ø 8 mm | 22,00 | 31,00 |

Placa inox 32

| Ref. | Diámetro | Euros 1 chaveta | Euros 2 chavetas |
|-----------|----------|-----------------|------------------|
| CP-32-3 | Ø 3 mm | 46,50 | 55,50 |
| CP-32-3,5 | Ø 3,5 mm | 42,00 | 51,00 |
| CP-32-4 | Ø 4 mm | 34,50 | 43,50 |
| CP-32-4,5 | Ø 4,5 mm | 34,50 | 43,50 |
| CP-32-5 | Ø 5 mm | 33,00 | 42,00 |
| CP-32-6 | Ø 6 mm | 33,00 | 42,00 |
| CP-32-7 | Ø 7 mm | 31,50 | 40,50 |
| CP-32-8 | Ø 8 mm | 31,50 | 40,50 |

Cintas de sierra para carne

Características 16 x 0,4 mm. Tamaño del diente 7 mm. Corte de carne fresca sin hueso o pequeños huesos

| Ref. | Largo | Unidades | Euros |
|----------|---------|----------|-------|
| SCA-1600 | 1600 mm | 4 | 39,00 |
| SCA-1740 | 1740 mm | 4 | 42,00 |
| SCA-1750 | 1750 mm | 4 | 42,00 |
| SCA-1985 | 1985 mm | 4 | 43,50 |
| SCA-2120 | 2120 mm | 4 | 45,00 |
| SCA-2340 | 2340 mm | 4 | 46,50 |
| SCA-2520 | 2520 mm | 4 | 51,00 |
| SCA-2930 | 2930 mm | 4 | 54,00 |

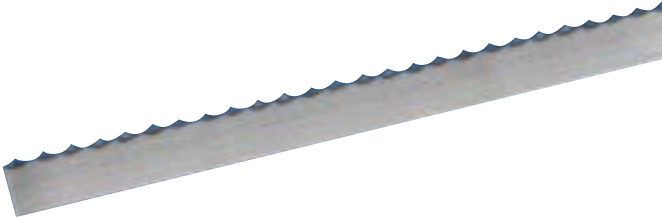
**Cintas de sierra para hueso**

Características 16 x 0,50 mm. Tamaño del diente 6,35 mm (4 dientes pulgada). Corte de hueso

| Ref. | Largo | Unidades | Euros |
|----------|---------|----------|-------|
| SHU-1600 | 1600 mm | 4 | 45,50 |
| SHU-1740 | 1740 mm | 4 | 48,00 |
| SHU-1750 | 1750 mm | 4 | 48,00 |
| SHU-1985 | 1985 mm | 4 | 53,00 |
| SHU-2120 | 2120 mm | 4 | 55,00 |
| SHU-2340 | 2340 mm | 4 | 57,00 |
| SHU-2520 | 2520 mm | 4 | 62,00 |
| SHU-2930 | 2930 mm | 4 | 71,50 |

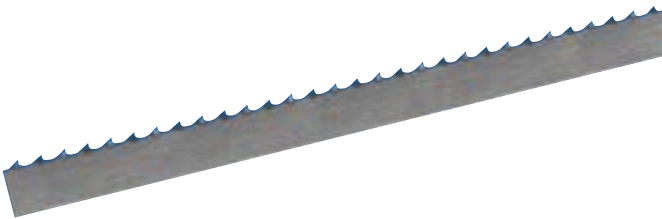
**Cintas de sierra para congelados**

Características 16 x 0,56 mm. Tamaño diente 8,46 mm (3 dientes/pulgada). Corte de carne, pescado y congelados

| Ref. | Largo | Unidades | Euros |
|----------|---------|----------|-------|
| SCO-1600 | 1600 mm | 4 | 45,50 |
| SCO-1740 | 1740 mm | 4 | 48,00 |
| SCO-1750 | 1750 mm | 4 | 48,00 |
| SCO-1985 | 1985 mm | 4 | 53,00 |
| SCO-2120 | 2120 mm | 4 | 55,00 |
| SCO-2340 | 2340 mm | 4 | 57,00 |
| SCO-2520 | 2520 mm | 4 | 62,00 |
| SCO-2930 | 2930 mm | 4 | 71,50 |

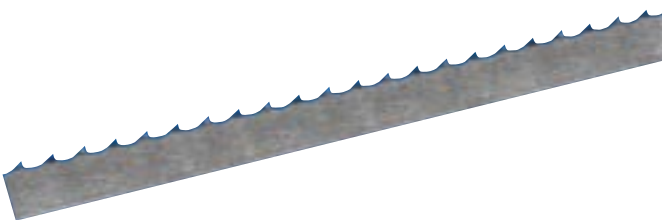



Máquina cortadora de magnífico diseño. fabricada íntegramente en aluminio anodizado con acabado satinado altamente pulido. Los componentes en contacto con el producto son completamente desmontables para facilitar su limpieza.

| Características técnicas | MC-E300 | MC-E350 | MC-M350 |
|----------------------------------|------------------|------------------|------------------|
| Cuchilla alemana teflonada | 300 | 350 | 350 |
| Potencia | 0.37 KW / 0.5 HP | 0.37 KW / 0.5 HP | 0.37 KW / 0.5 HP |
| Voltaje | 230 V | 230 V | 230 V |
| Espesor corte | 0-15 | 0-15 | 0-24 |
| Medidas exteriores | 519 x 620 x 450 | 560 x 695 x 520 | 590 x 840 x 550 |
| Medidas base apoyo A-L | 360 x 480 | 390 x 540 | 480 x 605 |
| Peso | 30 kg | 38 kg | 40 kg |
| Afilador incorporado | SI | SI | SI |
| Transmisión | CORREA | CORREA | DIRECTA |
| Aluminio anodizado anticorrosivo | SI | SI | SI |
| Capacidad corte (grosor) | 170 x 250 | 200 x 280 | 185 x 300 |
| Precio P.V.P | 2160,00 € | 2790,00 € | 3850,00 € |



MC-E300
MC-E350



MC-M350



Despiece



Ralladora mozzarella
 Cuerpo: acero inoxidable.
 Potencia: 0,35 HP.
 Motor monofásico 220 V.
 Peso 14 kg.
 Producción: 50 kg/h.

| Ref. | Euros |
|----------------|---------|
| MPQ-MOZZARELLA | 1160,00 |



Campana agujero 2 mm. para queso en hilo

| Ref. | Euros |
|------------|-------|
| MPQ-MOZ-15 | 94,00 |



Ralladora motor estanco HP 0,5,
Monofase 220 V.
Potencia 600 W.
Producción 50 kg/h

Incluye referencia DR-3

| Ref. | Medidas | Peso | Euros |
|--------|-----------------|---------|---------|
| MPQ-02 | 42 x 25 x 36 cm | 14,5 kg | 1295,00 |

AMPLIA GAMA DE DISCOS PARA RALLAR QUESOS DUROS Y BLANDOS, CHOCOLATE, CACAHUETES Y FRUTOS SECOS.



Disco parmesano para ref. MPQ-02

| Ref. | Euros |
|------|-------|
| DR-0 | 79,00 |

Disco agujero para ref. MPQ-02

| Ref. | Tipo | Euros |
|------|------|-------|
| DR-2 | 2 mm | 79,00 |
| DR-3 | 3 mm | 79,00 |
| DR-4 | 4 mm | 79,00 |
| DR-6 | 6 mm | 79,00 |
| DR-8 | 8 mm | 79,00 |

Disco hielo para ref. MPQ-02

| Ref. | Euros |
|------|-------|
| DRH | 95,00 |



EXPRIMIDOR CÍTRICOS

Exprimidor cítricos Santos nº 10.
Potencia 230 W.
Producción 30 L/H.

| Ref. | Medidas | Peso | Euros |
|--------|-----------------|--------|--------|
| MSE-10 | 30 x 20 x 38 cm | 9,5 kg | 890,00 |



Máquina ralladora-cortadora multifunción
 Cuerpo: acero inoxidable y aleación espe-
 cial.
 Potencia: HP 0,75.
 Motor: monofásico 230 V.
 Peso 20 kg.
 Producción: 150-300 kg/h.

| Ref. | Euros |
|----------|---------|
| MPQV-5-M | 1730,00 |

Máquina ralladora-cortadora multifunción
 Cuerpo: acero inoxidable y aleación
 especial.
 Potencia: HP 0,75.
 Motor: trifásico 230/380 V.
 Peso 20 kg.
 Producción: 150-300 kg/h.

| Ref. | Euros |
|----------|---------|
| MPQV-5-T | 1730,00 |

Despiece

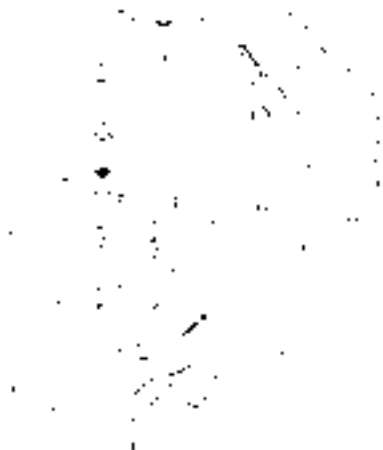

Medidas

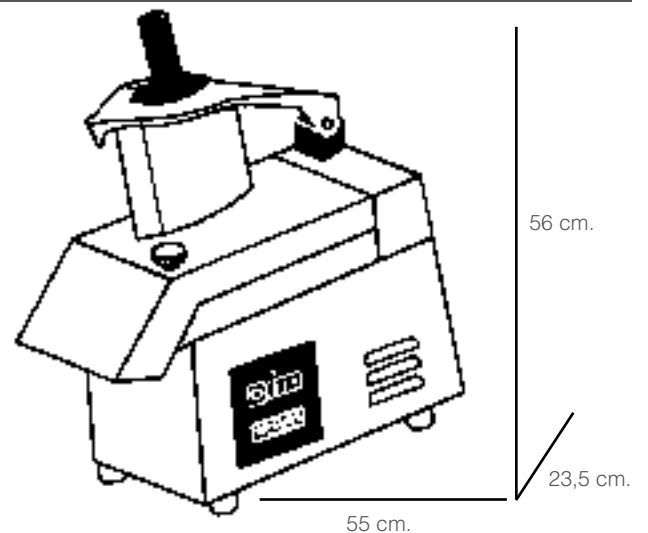

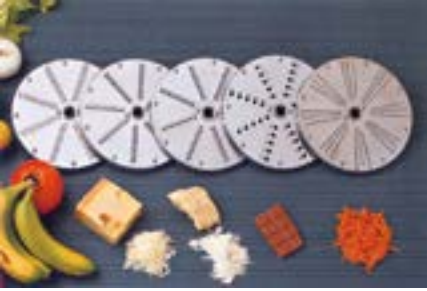

Disco para hilo

| Ref. | Tipo | Euros |
|------|------|-------|
| DZ-2 | 2 mm | 97,00 |
| DZ-3 | 3 mm | 97,00 |
| DZ-4 | 4 mm | 97,00 |
| DZ-7 | 7 mm | 97,00 |

Disco para polvo

| Ref. | Euros |
|------|-------|
| DV | 95,00 |

DISCO PARA CORTE EN RODAJAS

Disco para rodajas



| Ref. | Tipo | Euros |
|------|------|--------|
| DE-1 | 1 mm | 130,00 |
| DE-2 | 2 mm | 130,00 |
| DE-3 | 3 mm | 130,00 |
| DE-4 | 4 mm | 130,00 |



Disco para rodajas

| Ref. | Tipo | Euros |
|-------|-------|--------|
| DE-6 | 6 mm | 130,00 |
| DE-8 | 8 mm | 130,00 |
| DE-10 | 10 mm | 130,00 |
| DE-14 | 14 mm | 130,00 |

Accesorios rejilla a tiras (patatas fritas)



| Ref. | Tipo | Euros |
|-------|---------------|--------|
| DB-6 | 6 mm (DE-6) | 150,00 |
| DB-8 | 8 mm (DE-8) | 150,00 |
| DB-10 | 10 mm (DE-10) | 150,00 |



Accesorios rejilla cubos

| Ref. | Tipo | Euros |
|-------|--------------------|--------|
| DD-8 | 8 x 8 mm (DE-8) | 195,00 |
| DD-10 | 10 x 10 (DE-10) | 195,00 |
| DD-20 | 20 x 20 mm (DE-14) | 195,00 |

DISCO CURVO CORTE BLANDO EN RODAJAS TOMATES, NARANJA, LIMÓN, PLÁTANO, ETC



Disco curvado corte blando

| Ref. | Tipo | Euros |
|------|------|--------|
| DS-1 | 1 mm | 130,00 |
| DS-2 | 2 mm | 130,00 |
| DE-5 | 5 mm | 130,00 |

DISCO CORTE EN RODAJAS ONDULADAS



Disco para rodajas onduladas

| Ref. | Diámetro | Euros |
|--------|----------|--------|
| DH-2,5 | Ø 2,5 mm | 150,00 |
| DH-4 | Ø 4 mm | 150,00 |
| DH-6 | Ø 6 mm | 150,00 |
| DH-8 | Ø 8 mm | 150,00 |
| DH-10 | Ø 10 mm | 150,00 |

DISCO DE CORTE REGULABLE



Disco corte en rodajas regulable de 1 a 8 mm

| Ref. | Euros |
|------|--------|
| DX-1 | 265,00 |

ACCESORIOS DISCOS



Soporte portadiscos

| Ref. | Medidas | Euros |
|-------|---------------------|-------|
| DA-18 | 39,5 x 25,6 x 10 cm | 75,00 |

Disco expulsor para ref. MPQV-5

| Ref. | Euros |
|------|-------|
| DA-1 | 39,00 |



Cutter 3 L
 Cuerpo: acero inoxidable.
 Potencia : 480W.
 Motor: monofásico 230 V.
 Velocidad variable: 900-2200 rpm.
 Peso: 11 kg.
 Dimensiones cubeta: 18 Ø x 10,5 cm altura.
 Incluye cuchilla lisa.

| Ref. | Euros |
|------|---------|
| MC-3 | 1500,00 |

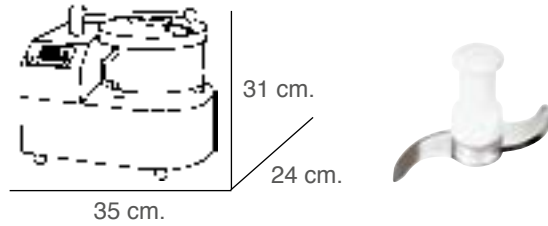

MC-CL-X - Cuchilla lisa afilada para triturar

| Ref. | Tipo | Euros |
|---------|------------|--------|
| MC-CL-3 | MC-3 | 108,00 |
| MC-CL-5 | MC-5, MC-8 | 163,00 |



MC-CD-X - Cuchilla dentada para triturar

| Ref. | Tipo | Euros |
|---------|------------|--------|
| MC-CD-3 | MC-3 | 108,00 |
| MC-CD-5 | MC-5, MC-8 | 163,00 |



MC-CP-X - Cuchilla perforada para batir y amasar

| Ref. | Tipo | Euros |
|---------|------------|--------|
| MC-CP-3 | MC-3 | 108,00 |
| MC-CP-5 | MC-5, MC-8 | 163,00 |



Puré de tomate

Mayonesa

Perejil, ajo, cebolla, pimiento triturado

Pan rallado

Chocolate



Frutos secos triturados

Mozzarella para pizza

Carne triturada

Amasijos tiernos para pastelería Puré de verduras



Cutter 5 L
 Cuerpo: acero inoxidable.
 Potencia : 960W.
 Motor: monofásico 230 V.
 Velocidad variable: 900-2200 rpm.
 Peso: 18 kg.
 Dimensiones cubeta: 24 Ø x 12 cm altura.
 Incluye cuchilla lisa.

| Ref. | Euros |
|------|---------|
| MC-5 | 1895,00 |

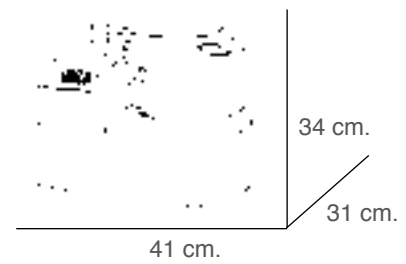

Cutter 8 L
 Cuerpo: acero inoxidable.
 Potencia : 960W.
 Motor: monofásico 230 V.
 Velocidad variable: 900-2200 rpm.
 Peso: 19 kg.
 Dimensiones cubeta: 24 Ø x 18 cm altura.
 Incluye cuchilla lisa.

| Ref. | Euros |
|------|---------|
| MC-8 | 2060,00 |

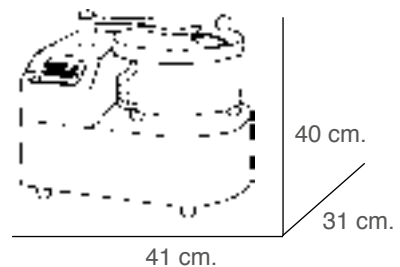

3 MOLINO PIMIENTA



Molino pimienta
Potencia: 1 HP.
Producción: 12 kg/h.

| Ref. | Medidas | Peso | Euros |
|--------|-----------------|-------|--------|
| MPP-10 | 22 x 34 x 61 cm | 12 kg | 950,00 |

AFILADORA



Afilador mini
Afilado: 2 piedras: 1 afilado y 1 pulido

| Ref. | Medidas | Voltaje (V) | Euros |
|-------|---------------|-------------|--------|
| A-198 | 22 x 9 x 8 cm | 220 | 145,00 |



Juego 2 piedras con eje para ref. A-198

| Ref. | Euros |
|---------|-------|
| A-198-1 | 35,00 |



Aflar



Pulir



Máquina afilar banda
Potencia: 0,35 HP.
Revoluciones: 2800 rpm.
Motor: monofásico 220 V.

| Ref. | Medidas | Voltaje (V) | Peso | Euros |
|-------|-----------------|-------------|------|--------|
| A-200 | 33 x 28 x 40 cm | 220 | 9 kg | 725,00 |

Despiece



Banda afilar para ref. A-200

| Ref. | Euros |
|--------------------|-------|
| A-200-13 | 7,00 |
| A-200-13X Circonio | 6,00 |

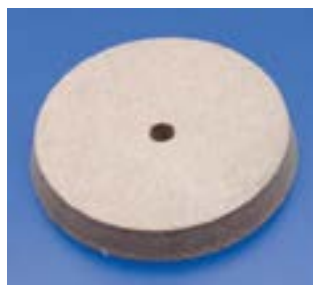

Disco pulir para ref. A-200

| Ref. | Euros |
|----------|-------|
| A-200-33 | 70,00 |

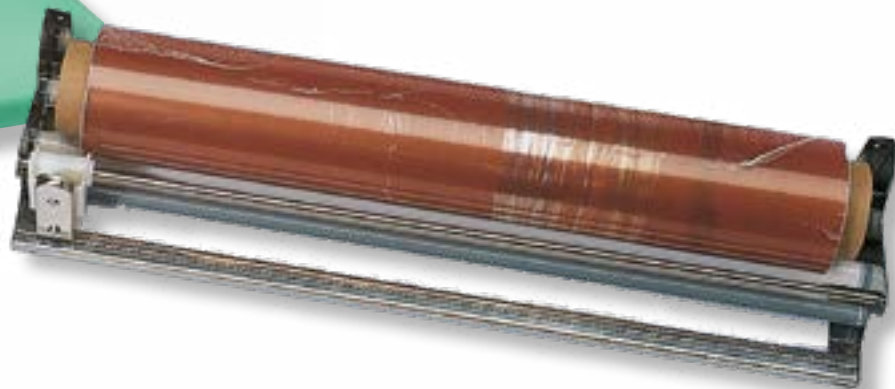

4

Máquinas retractilar

Film

Dispensadores de film

Dispensador papel aluminio

Soldadoras de bolsas

Máquina vacío

Bolsas vacío

Parrilla y palas envasadoras

Termoselladoras



Máquina retractilar, acero-inox
Con placa de calor.
Interruptor para placa calor ON/OFF.
Interruptor para resistencia corte ON/OFF.

| Ref. | Medidas | Resistencia corte | Bobina film | Voltaje (V) | Euros |
|--------------|---------------------|-------------------|-------------|-------------|--------|
| MR-4-ECO | 59 x 48,5 x 13,5 cm | 46 cm | MR-40/45 | 220 | 225,00 |
| MR-4-500-ECO | 59 x 52 x 13,5 cm | 50 cm | MR-40/45/47 | 220 | 288,00 |



Máquina retractilar, acero-inox
Con placa de calor.
Interruptor para placa calor ON/OFF.
Interruptor para resistencia corte ON/OFF.

| Ref. | Molde medidas | Resistencia corte | Voltaje (V) | Bobina film | Euros |
|----------|---------------------|-------------------|-------------|----------------|--------|
| MR-4 | 59 x 48,5 x 13,5 cm | 45 cm | 220 | MR-40/45 | 270,00 |
| MR-4-500 | 59 x 52 x 13,5 cm | 50 cm | 220 | MR-40/45/47 | 335,00 |
| MR-4-600 | 65 x 62 x 13,4 cm | 60 cm | 220 | MR-40/45/46/47 | 445,00 |



Máquina retractilar
Con placa de calor.
Interruptor para placa calor ON/OFF.
Interruptor para resistencia corte ON/OFF.
Ideal para espacios reducidos al llevar la bobina de film en su interior.

| Ref. | Medidas | Bobina film | Resistencia corte | Euros |
|------|-----------------|-------------|-------------------|--------|
| MR-1 | 48 x 45 x 19 cm | MR-20/30 | 45 cm | 305,00 |

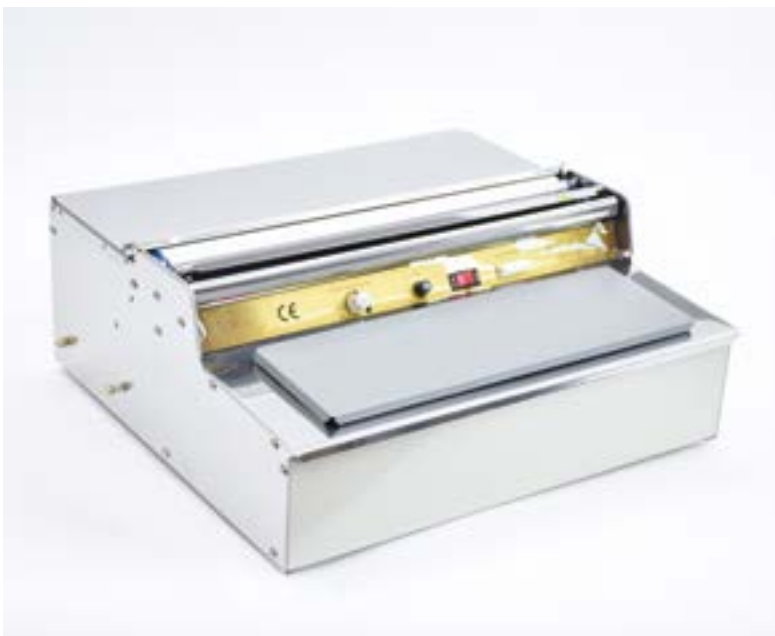

Máquina retractilar
Con placa de calor.
Interruptor para placa calor ON/OFF.
Interruptor para resistencia corte ON/OFF.
Ideal para espacios reducidos al llevar la bobina de film en su interior.

| Ref. | Medidas | Bobina film | Resistencia corte | Euros |
|----------|-----------------|-------------|-------------------|--------|
| MR-1-ECO | 48 x 45 x 19 cm | MR-20/30 | 46 cm | 255,00 |



Máquina retractilar
Sin placa de calor.
Interruptor ON/OFF.

| Ref. | Medidas | Resistencia corte | Bobina film | Voltaje (V) | Euros |
|------|---------------------|-------------------|-------------|-------------|--------|
| MR-2 | 48,5 x 27 x 17,5 cm | 45 cm | MR-20 | 220 | 235,00 |



Máquina retractilar
Sin placa de calor.
Interruptor ON/OFF.

| Ref. | Medidas | Resistencia corte | Bobina film | Voltaje (V) | Euros |
|------|---------------------|-------------------|-------------|-------------|--------|
| MR-3 | 34,5 x 27 x 17,5 cm | 30 cm | MR-30 | 220 | 195,00 |



Bobinas de film

| Ref. | Medidas | Euros |
|-------|--------------|--------|
| MR-20 | 40 x 500 cm | 32,00 |
| MR-30 | 30 x 500 cm | 24,00 |
| MR-40 | 40 x 1500 cm | 69,00 |
| MR-45 | 45 x 1500 cm | 79,00 |
| MR-47 | 50 x 1500 cm | 94,00 |
| MR-46 | 60 x 1500 cm | 115,00 |
| MR-49 | 90 x 1500 cm | 165,00 |
| MR-50 | 30 x 300 cm | 12,00 |
| MR-60 | 45 x 300 cm | 16,50 |



Papel de aluminio

| Ref. | Medidas | Euros |
|-------|-------------|-------|
| MR-80 | 29 x 300 cm | 42,00 |
| MR-90 | 40 x 300 cm | 48,00 |



Dispensador inox con cuchilla
Posición sobre mesa ó pared.

| Ref. | Medidas | Bobina film | Euros |
|---------|----------------------|-----------------------|-------|
| MR-10 | 36 x 12,5 x 9 cm | MR-50 | 80,00 |
| MR-11 | 50 x 12,5 x 9 cm | MR-60 | 90,00 |
| MR-10-1 | Cuchilla para | MR-10, 11, 12, 13, 14 | 11,00 |



Dispensador inox con cuchilla
Posición sobre mesa.

| Ref. | Medidas | Bobina film | Euros |
|-------|----------------|-------------|--------|
| MR-12 | 50 x 22 x 9 cm | MR-45 | 170,00 |
| MR-13 | 63 x 22 x 9 cm | MR-46/47 | 260,00 |
| MR-14 | 95 x 22 x 9 cm | MR-49 | 425,00 |



Dispensador inox. film-papel aluminio
Posición sobremesa o pared.

| Ref. | Medidas | Euros |
|------|-------------------|-------|
| MR-7 | 35 x 16,5 x 11 cm | 79,00 |
| MR-8 | 50 x 16,5 x 11 cm | 87,00 |



Dispensador metálico
Con kit de cuchilla para corte.

| Ref. | Medidas | Bobina film | Euros |
|------|----------------|-------------|-------|
| MR-5 | 34 x 16 x 9 cm | MR-50 | 48,00 |
| MR-6 | 49 x 16 x 9 cm | MR-60 | 56,00 |



Soldadora de bolsas
Con regulador de temperatura
Posición sobremesa.

| Ref. | Maximum seal | Voltaje (V) | Euros |
|--------|--------------|-------------|--------|
| SB-200 | 20 cm | 220 | 165,00 |
| SB-300 | 30 cm | 220 | 194,00 |
| SB-400 | 40 cm | 220 | 224,00 |
| SB-500 | 50 cm | 220 | 345,00 |



Soldadora de bolsas
Con regulador de temperatura.

| Ref. | Maximum seal | Voltaje (V) | Euros |
|---------|--------------|-------------|--------|
| SB-600 | 60 cm | 220 | 650,00 |
| SB-1000 | 100 cm | 220 | 875,00 |



Soldadora de bolsas
Con regulador de temperatura
Posición sobremesa.

| Ref. | Maximum seal | Voltaje (V) | Euros |
|------------|--------------|-------------|--------|
| SB-400-ECO | 40 cm | 220 | 144,00 |
| SB-500-ECO | 50 cm | 220 | 255,00 |



Soldador semiautomático con pedal
Pedal eléctrico
Ancho sellado de 5 mm.

| Ref. | Medidas | Maximum seal | Voltaje (V) | Euros |
|----------|-------------------|--------------|-------------|---------|
| SBPA-450 | 53,5 x 38 x 88 cm | 45 cm | 220 | 1300,00 |
| SBPA-600 | 68 x 38 x 88 cm | 60 cm | 220 | 1620,00 |



Máquina envasadora al vacío
Estructura + cuba en acero inox.
6 programas memoria, con pantalla digital.

| Ref. | Dimensiones máquina | Dimensiones cámara | Soldadura | Peso | Bomba vacío | Voltaje (V) | Euros |
|--------------|---------------------|--------------------|---------------|-------|-------------|-------------|----------------|
| MV-10 | 410 x 460 x 460 mm | 310 x 350 x 190 mm | 300 mm x 5 mm | 38 kg | 10 M3/h | 230V / 50hz | 2580,00 |
| MV-16 | 510 x 560 x 480 mm | 410 x 450 x 220 mm | 400 mm x 5mm | 48 kg | 25 M3/h | 230V / 50hz | 2980,00 |
| MV-21 | 610 x 630 x 500 mm | 520 x 520 x 200 mm | 500 mm x 5 mm | 60 kg | 25 M3/h | 230V / 50hz | 3990,00 |



Máquina envasadora al vacío sin cámara
Estructura acero-inox
Bolsa gofrada.

| Ref. | Medidas | Barra soldadura | Bomba vacío | Peso | Voltaje (V) | Euros |
|----------------|--------------------|-----------------|-------------|-------|-----------------|---------------|
| MVS-430 | 490 x 295 x 180 mm | 430 mm x 4 mm | 28 L/min. | 10 kg | 220V / 50hz 95W | 850,00 |

4 MÁQUINA ENVASADORA AL VACÍO



Máquina envasadora al vacío sin cámara
Estructura de ABS.
Bolsa gofrada.

| Ref. | Medidas | Barra soldadura | Bomba vacío | Voltaje (V) | Euros |
|---------|-----------------|-----------------|-------------|-------------|--------|
| MVS-330 | 38 x 18 x 11 cm | 330 mm | 16 Lt/min. | 220V | 340,00 |

PARRILLA ENVASADORA



Parrilla envasadora para bolsa vacío
Base polietileno.
Varillas acero inox.
Pomo giratorio.

| Ref. | Medidas | Euros |
|------|--------------|--------|
| A-75 | 18,5 x 27 cm | 105,00 |



Pala envasadora para bolsa vacío
Base polietileno.

| Ref. | Medidas | Euros |
|------|------------|-------|
| A-76 | 38 x 18 cm | 14,00 |
| A-77 | 34 x 15 cm | 13,00 |



Bolsa vacío gofrada

| Ref. | Medidas | Unidades | Euros |
|----------|------------|----------|-------|
| BVX-1525 | 15 x 25 cm | 100 | 10,00 |
| BVX-1535 | 15 x 35 cm | 100 | 13,00 |
| BVX-1545 | 15 x 45 cm | 100 | 17,00 |
| BVX-2020 | 20 x 20 cm | 100 | 10,00 |
| BVX-2030 | 20 x 30 cm | 100 | 15,50 |
| BVX-2040 | 20 x 40 cm | 100 | 20,00 |
| BVX-2535 | 25 x 35 cm | 100 | 22,00 |
| BVX-3040 | 30 x 40 cm | 100 | 30,00 |
| BVX-3050 | 30 x 50 cm | 100 | 37,00 |



Rollo gofrado 20 x 600

| Ref. | Medidas | Unidades | Euros |
|---------|-------------|----------|-------|
| BVX-R15 | 15 x 600 cm | 2 | 8,00 |
| BVX-R20 | 20 x 600 cm | 2 | 10,00 |
| BVX-R25 | 25 x 600 cm | 2 | 12,00 |
| BVX-R30 | 30 x 600 cm | 2 | 14,00 |
| BVX-R40 | 40 x 600 cm | 2 | 19,00 |

Bolsa vacío gofrada cocción

| Ref. | Medidas | Unidades | Euros |
|-------------|------------|----------|-------|
| BVXC-200300 | 20 x 30 cm | 1000 | 37,00 |

CONSULTAR PRECIO PARA OTRAS MEDIDAS



4 BOLSAS VACIO



Bolsa vacío M8 COEX

| Ref. | Medidas | Unidades | Euros |
|-----------|--------------|----------|--------|
| BV-140450 | 14 x 45 cm | 1000 | 102,00 |
| BV-150200 | 15 x 20 cm | 1000 | 49,00 |
| BV-150250 | 15 x 25 cm | 1000 | 61,00 |
| BV-175250 | 17,5 x 25 cm | 1000 | 71,00 |
| BV-180300 | 18 x 30 cm | 1000 | 88,00 |
| BV-200200 | 20 x 20 cm | 1000 | 65,00 |
| BV-200250 | 20 x 25 cm | 1000 | 82,00 |
| BV-200300 | 20 x 30 cm | 1000 | 98,00 |
| BV-200350 | 20 x 35 cm | 1000 | 114,00 |
| BV-200400 | 20 x 40 cm | 1000 | 130,00 |
| BV-250350 | 25 x 35 cm | 1000 | 142,00 |
| BV-300400 | 30 x 40 cm | 1000 | 195,00 |
| BV-350500 | 35 x 50 cm | 500 | 142,00 |
| BV-350600 | 35 x 60 cm | 500 | 170,00 |
| BV-400500 | 40 x 50 cm | 500 | 163,00 |
| BV-400600 | 40 x 60 cm | 500 | 195,00 |

Bolsas vacío plata-transparente

| Ref. | Medidas | Unidades | Euros |
|------------|--------------|----------|--------|
| BVP-175250 | 17,5 x 25 cm | 1000 | 126,00 |
| BVP-175300 | 17,5 x 30 cm | 1000 | 150,00 |
| BVP-200250 | 20 x 25 cm | 1000 | 143,00 |
| BVP-200300 | 20 x 30 cm | 1000 | 169,00 |

Bolsa vacío M15 COEX

| Ref. | Medidas | Unidades | Euros |
|------------|------------|----------|--------|
| BVE-200300 | 20 x 30 cm | 500 | 97,00 |
| BVE-250350 | 25 x 35 cm | 500 | 141,00 |
| BVE-300400 | 30 x 40 cm | 500 | 193,00 |
| BVE-350450 | 35 x 45 cm | 300 | 152,00 |
| BVE-350600 | 35 x 60 cm | 300 | 203,00 |
| BVE-400600 | 40 x 60 cm | 300 | 232,00 |

Bolsa vacío cocción a 121° C

| Ref. | Medidas | Unidades | Euros |
|------------|--------------|----------|--------|
| BVC-150200 | 15 x 20 cm | 1000 | 93,00 |
| BVC-185250 | 18,5 x 25 cm | 1000 | 142,00 |
| BVC-200300 | 20 x 30 cm | 500 | 92,00 |
| BVC-250350 | 25 x 35 cm | 500 | 135,00 |
| BVC-300400 | 30 x 40 cm | 500 | 185,00 |
| BVC-350600 | 35 x 60 cm | 500 | 324,00 |





Termoselladora de barquetas 400 W
Incluye molde 95 x 135 y 135 x 195

| Ref. | Medidas | Voltaje (V) | Euros |
|--------|--------------|-------------|---------|
| MT-152 | 18,7 x 40 cm | 230 | 1260,00 |



Termoselladora de barquetas 600 W 1/4 GASTRONORM

| Ref. | Medidas | Voltaje (V) | Euros |
|--------|--------------|-------------|---------|
| MT-192 | 22,8 x 49 cm | 230 | 1550,00 |

Molde medidas
GN-1/4 barquetas para MT-192

| Ref. | Medidas | Euros |
|---------|----------------|--------|
| MTM-1/4 | 26,4 x 16,2 cm | 298,00 |



Bobina film termosellar

| Ref. | Medidas | Euros |
|--------|-------------|-------|
| MTB-15 | 15 x 300 cm | 26,00 |
| MTB-20 | 20 x 300 cm | 36,00 |
| MTB-27 | 27 x 300 cm | 46,00 |



5

Secamanos

Dispensador papel celulosa

Papel celulosa

Dosificadores de jabón

Grifos

Lavamanos

Grifos ducha

Portacuchillos

Papeleras

Cañón de ozono

Esterilizadores de cuchillos

Contenedores plástico

Contenedores papeleras acero-inoxidable



Secamanos
Control: célula de infrarrojos por proximidad.
Caudal Aire : 225 m3/h.
Interruptor aire: frío-caliente.
Potencia 1650W

| Ref. | Medidas | Voltaje (V) | Peso | Euros |
|------|-----------------|-------------|--------|--------|
| SM-5 | 14 x 27 x 22 cm | 220 | 2,4 kg | 130,00 |



Secamanos
Control: célula de infrarrojos por proximidad.
Caudal aire: 270 m3/h.
Carcasa: acero satinado.
Potencia 2500W

| Ref. | Medidas | Voltaje (V) | Peso | Euros |
|------|-----------------|-------------|---------|--------|
| SM-6 | 20 x 26 x 21 cm | 220 | 6,26 kg | 289,00 |

DISPENSADORES DE PAPEL CELULOSA



Portabobinas plegable suelo acero-inox
Tipo de papel: celulosa ref. PB-10

| Ref. | Medidas | Euros |
|------|-----------------|-------|
| PB-1 | 40 x 45 x 83 cm | 39,00 |



Portabobinas mural y sobremesa acero-inox
Tipo de papel: celulosa ref. PB-10

| Ref. | Euros |
|--------|-------|
| PB-1-M | 39,00 |



Portarrollos higiénico inox

| Ref. | Diámetro | Largo | Euros |
|------|----------|---------|-------|
| PB-2 | Ø 25 cm | 11,5 cm | 45,00 |



**Portarrollos higiénico epoxi blanco
Eje 4,5. Tipo de papel : celulosa ref. PB-30**

| Ref. | Diámetro | Largo | Euros |
|------|----------|---------|-------|
| PB-3 | Ø 25 cm | 11,5 cm | 48,00 |



**Portarrollos higiénico WC
Con visor.**

| Ref. | Medidas | Color | Euros |
|--------|---------------------|-------|-------|
| PB-21 | 32,5 x 30,5 x 13 cm | ○ | 22,00 |
| PB-21N | 32,5 x 30,5 x 13 cm | ● | 32,00 |



Dispensador de papel tipo mecha
Tipo de papel : celulosa ref. PB-50

| Ref. | Medidas | Euros |
|------|--------------|-------|
| PB-9 | 26,5 x 35 cm | 41,00 |



Dispensador papel tipo mecha
Con visor.

| Ref. | Medidas | Color | Euros |
|--------|-----------------|-------|-------|
| PB-24 | 32 x 21 x 22 cm | ○ | 25,00 |
| PB-24N | 32 x 21 x 22 cm | ● | 38,00 |



Dispensador papel tipo mecha
Tipo papel: ref. PB-50

| Ref. | Diámetro | Altura | Euros |
|-------|----------|--------|--------|
| PB-12 | Ø 32 cm | 25 cm | 170,00 |



Dispensador de papel tipo mecha mini
Tipo de papel : celulosa ref. PB-40

| Ref. | Medidas | Euros |
|-------|------------|-------|
| PB-11 | 15 x 27 cm | 35,00 |



Dispensador de papel tipo mecha mini
Con visor

| Ref. | Medidas | Color | Euros |
|-------|-----------------|-------|-------|
| PB-23 | 14 x 16 x 29 cm | ● | 20,00 |



Dispensador de papel tipo mecha mini
Con visor

| Ref. | Medidas | Color | Euros |
|--------|-----------------|-------|-------|
| PB-23N | 14 x 16 x 29 cm | ● | 27,00 |



Dispensador toallitas Z/Z acero inox
Tipo de papel : ref. PB-70

| Ref. | Medidas | Euros |
|------|-------------------|-------|
| PB-8 | 33 x 26,5 x 12 cm | 55,00 |



Dispensador toallitas Z/Z epoxi blanco
Tipo de papel : ref. PB-70

| Ref. | Medidas | Euros |
|------|-------------------|-------|
| PB-7 | 31 x 26,5 x 12 cm | 55,00 |



Dispensador toallitas Z/Z ABS
Con visor.

| Ref. | Medidas | Color | Euros |
|--------|---------------------|-------|-------|
| PB-22 | 37 x 27,5 x 13,5 cm | ○ | 20,00 |
| PB-22N | 37 x 27,5 x 13,5 cm | ● | 36,00 |



**Bobina de celulosa industrial
2 capas
Para portabobinas ref. PB-1 / PB-1-M**

| Ref. | Largo | Unidades | Euros |
|-------|-------|----------|-------|
| PB-10 | 500 m | 2 | 57,00 |

**Bobina minimecha
2 capas
Para dispensador ref. PB-11 / PB-23 / PB-23-N**

| Ref. | Largo | Unidades | Euros |
|-------|-------|----------|-------|
| PB-40 | 65 m | 12 | 41,00 |

**Rollo papel higiénico
2 capas
Para portarrollos ref. PB-2 / PB-3 / PB-21 / PB-21-N**

| Ref. | Largo | Unidades | Euros |
|-------|-------|----------|-------|
| PB-30 | 150 m | 18 | 55,00 |

**Bobina mecha
2 capas
Para dispensador ref. PB-9 / PB-12 / PB-24 / PB-24-N**

| Ref. | Largo | Unidades | Euros |
|-------|-------|----------|-------|
| PB-50 | 180 m | 6 | 51,00 |

**Tallitas Z/Z
200 unidades x 20 paquetes
Para dispensador ref. PB-7 / PB-8 / PB-22 / PB-22-N**

| Ref. | Euros |
|-------|-------|
| PB-70 | 45,00 |



Dosificador de jabón luxe

| Ref. | Medidas | Capacidad | Euros |
|------|------------|-----------|-------|
| D-1 | 12 x 11 cm | 1 l | 26,00 |



Dosificador de jabón

| Ref. | Medidas | Capacidad | Euros |
|------|------------|-----------|-------|
| D-2 | 13 x 24 cm | 2 l | 37,00 |



**Dosificador de jabón
Color blanco**

| Ref. | Medidas | Capacidad | Euros |
|-------|------------------|-----------|-------|
| D-4-B | 9 x 10 x 22,5 cm | 1 l | 24,50 |



Dosificador jabón cromado

| Ref. | Medidas | Capacidad | Euros |
|-------|------------------|-----------|-------|
| D-4-C | 9 x 10 x 22,5 cm | 1 l | 42,00 |



**Dosificador jabón
Color blanco o negro. Con visor**

| Ref. | Medidas | Capacidad | Euros |
|-------|--------------------|-----------|-------|
| D-7 | 13 x 9,5 x 21,5 cm | 0,8 l | 18,00 |
| D-7-N | 13 x 9,5 x 21,5 cm | 0,8 l | 22,00 |



Dosificador de jabón

| Ref. | Medidas | Capacidad | Euros |
|------|----------------------|-----------|-------|
| D-8 | 11,6 x 5,8 x 17,5 cm | 0,8 l | 43,00 |



**Dosificador de jabón
electrónico
Color blanco**

| Ref. | Medidas | Capacidad | Euros |
|------|---------------------|-----------|-------|
| D-11 | 14 x 11,8 x 23,4 cm | 1 l | 46,00 |



**Dosificador de gel electrónico
Color blanco**

| Ref. | Medidas | Capacidad | Euros |
|------|-----------------|-----------|-------|
| D-12 | 13 x 12 x 27 cm | 0,9 l | 40,00 |



**Grifo con kit electrónico
Sensor infrarrojo.**

| Ref. | Voltaje (V) | Tensión de trabajo (V) | Euros |
|-------|-------------|------------------------|--------|
| LM-10 | 220 | 12 | 280,00 |

**Grifo con kit electrónico pilas
Grifo un agua.
Sensor infrarrojo.
4 pilas AA de 1,5V**

| Ref. | Tensión de trabajo (V) | Euros |
|---------|------------------------|--------|
| LM-10-P | 6 | 255,00 |



**Lavamanos inox con pulsa-
dor de pie
Mezclador agua fría
y caliente.
Caño giratorio.
Alto mas 30 cm de PETO**

| Ref. | Medidas | Euros |
|------|-----------------|--------|
| LM-1 | 45 x 45 x 86 cm | 420,00 |



**Lavamanos inox con pedal
Mezclador agua fría
y caliente.
Caño fijo.**

| Ref. | Medidas | Euros |
|------|-----------------|--------|
| LM-2 | 45 x 45 x 85 cm | 448,00 |

**Lavamanos inox
con 2 pedales
Mezclador agua fría y caliente.**

| Ref. | Medidas | Euros |
|--------|-----------------|--------|
| LM-2-P | 45 x 45 x 85 cm | 448,00 |



**Lavamanos inox mural
Con mezclador.
Pulsador de rodilla.
Caño giratorio**

| Ref. | Medidas | Euros |
|------|-------------------|--------|
| LM-4 | 35 x 30 x 21,5 cm | 205,00 |

Peto para ref. LM-4

| Ref. | Euros |
|-------|-------|
| LMP-4 | 40,00 |



**Lavamanos inox mural
Pulsador de rodilla. Mezclador
agua fría y caliente.
Caño fijo.**

| Ref. | Medidas | Euros |
|------|-------------------|--------|
| LM-5 | 45 x 45 x 21,5 cm | 252,00 |

Peto para ref. LM-4

| Ref. | Euros |
|-------|-------|
| LMP-5 | 40,00 |



Caño giratorio eco

| Ref. | Euros |
|--------|-------|
| LM-1-2 | 29,50 |

Pedal 1 agua

| Ref. | Euros |
|--------|-------|
| LM-2-1 | 52,00 |

Válvula mezcladora 2 aguas

| Ref. | Euros |
|-------|-------|
| LM-11 | 29,50 |

Caño giratorio reforzado

| Ref. | Euros |
|--------|-------|
| LM-1-3 | 54,00 |

Pedal 2 aguas

| Ref. | Euros |
|--------|-------|
| LM-2-2 | 99,00 |

Pulsador temporizador

| Ref. | Euros |
|--------|-------|
| LM-1-1 | 42,00 |



Grifo ducha extensible
de un agua
Piña negra

| Ref. | Euros |
|-------|--------|
| LM-23 | 240,00 |

Grifo ducha extensible
de un agua.
Piña blanca.

| Ref. | Euros |
|-------|--------|
| LM-21 | 230,00 |



Grifo ducha extensible
de dos aguas.
Piña negra.

| Ref. | Euros |
|-------|--------|
| LM-24 | 255,00 |

Grifo ducha extensible
de dos aguas.
Piña blanca.

| Ref. | Euros |
|-------|--------|
| LM-22 | 250,00 |



Piña ducheta blanca para
ref. LM-21 y LM-22

| Ref. | Euros |
|---------|-------|
| LM-21-1 | 88,00 |

Piña ducheta negra para ref. L-23 y LM-24

| Ref. | Euros |
|---------|-------|
| LM-23-1 | 88,00 |

Flexo ducheta, 120 cm, transparente

| Ref. | Para | Euros |
|---------|--------|-------|
| LM-23-2 | 120 cm | 27,00 |

Flexo ducheta, 150 cm, transparente

| Ref. | Para | Euros |
|---------|--------|-------|
| LM-23-3 | 150 cm | 29,00 |



Mural dos aguas

| Ref. | Euros |
|-------|-------|
| LM-26 | 75,00 |



Caño giratorio acoplable para grifos ducha.

| Ref. | Euros |
|-------|-------|
| LM-25 | 88,00 |



**Caño giratorio con monomando codo
Acoplable para grifos ducha**

| Ref. | Euros |
|-------|--------|
| LM-27 | 227,00 |



Portacuchillos protegido, acero-inox
Con tres ranuras para cuchillos y chaira ovalada-redonda

| Ref. | Medidas | Euros |
|-------|----------------|--------|
| EC-10 | 38 x 9 x 38 cm | 125,00 |



Papelera rejilla, acero-inox

| Ref. | Medidas | Euros |
|------|------------------|-------|
| A-95 | 60 x 7,5 x 22 cm | 44,00 |



Papelera, acero inox

| Ref. | Medidas | Euros |
|------|-------------------|-------|
| A-90 | 33 x 13 x 27,5 cm | 79,00 |



Cañón de ozono 10 G/H con temporizador.
Producción 10 gramos hora.

| Ref. | Medidas | Voltaje (V) | Euros |
|--------|-----------------|-------------|--------|
| OZ-10G | 23 x 18 x 17 cm | 220 V | 185,00 |



Armario esterilizador por lámpara de ozono
2 barras de imán.
Puerta de metacrilato transparente para poder acceder totalmente a su interior.
Acero inox.

| Ref. | Medidas | Voltaje (V) | Euros |
|-------|-----------------|-------------|--------|
| EC-35 | 35 x 58 x 12 cm | 220 | 625,00 |



Armario esterilizador por lámpara de ozono
2 barras de imán.
Puerta de metacrilato para poder acceder totalmente a su interior. Acero-inox.

Techo inclinado

| Ref. | Medidas | Voltaje (V) | Euros |
|-------|-----------------|-------------|--------|
| EC-55 | 47 x 58 x 12 cm | 220 | 735,00 |



Armario esterilizador por lámpara de ozono
4 barras de imán.
Puerta de metacrilato transparente para poder acceder totalmente a su interior.
Acer inox.

Techo inclinado

| Ref. | Medidas | Voltaje (V) | Euros |
|--------|------------------|-------------|---------|
| EC-105 | 100 x 59 x 12 cm | 220 | 1130,00 |



Esterilizador de cuchillos por ozono
Acero-inox, Duración aconsejable 15 minutos

| Ref. | Medidas | Voltaje (V) | Euros |
|------|-----------------|-------------|--------|
| EC-1 | 60 x 10 x 35 cm | 220 V | 430,00 |



Armario esterilizador ultravioleta
Soporte inox 10 cuchillos.
Puerta plexiglas transparente ahumado.
Lámpara: UVC 15W.
Temporizador: reloj 0 a 2 horas.
Duración aconsejada 1h 30.
Acero-inox.

| Ref. | Medidas | Voltaje (V) | Euros |
|--------|---------------------|-------------|--------|
| ECU-25 | 35 x 12,5 x 57,5 cm | 220 | 370,00 |



Armario esterilizador ultravioleta
Soporte: inox 20 cuchillos.
Puerta: plexiglas transparente ahumado.
Lámpara: UVC 15W.
Temporizador: reloj 0 a 2h.
Duración aconsejada: 1h 30.
Acero-inox.

| Ref. | Medidas | Voltaje (V) | Euros |
|--------|---------------------|-------------|--------|
| ECU-50 | 44 x 12,5 x 57,5 cm | 220 | 405,00 |



Armario esterilizador ultravioleta
Soporte: inox 30 cuchillos.
Puerta: plexiglas transparente ahumado.
Lámpara 2x15W.
Temporizador: reloj 0 a 2 horas.
Duración aconsejada: 1h 30.
Acero-inox.

| Ref. | Medidas | Voltaje (V) | Euros |
|---------|---------------------|-------------|--------|
| ECU-100 | 75 x 12,5 x 57,5 cm | 220 | 725,00 |



Carro contenedor de basura
Tapa abatible con pedal.

| Ref. | Medidas | Capacidad | Color | Euros |
|------|---------------------|-----------|-------|--------|
| W-60 | 50,5 x 44,5 x 70 cm | 60 l | ○ ● ● | 125,00 |



Carro contenedor de basura
Tapa abatible con pedal.

| Ref. | Medidas | Capacidad | Color | Euros |
|------|-----------------------|-----------|-------|--------|
| W-80 | 50,5 x 44,5 x 84,5 cm | 80 l | ● ● | 130,00 |



Carro contenedor de basura
Tapa abatible con pedal.

| Ref. | Medidas | Capacidad | Color | Euros |
|------|-----------------|-----------|-------|--------|
| W-81 | 55 x 58 x 93 cm | 80 l | ○ | 105,00 |



Carro contenedor de basura
Tapa abatible con pedal.

| Ref. | Medidas | Capacidad | Color | Euros |
|-------|-----------------|-----------|-------------------|--------|
| W-120 | 55 x 58 x 93 cm | 120 l | ○ ● ● ● ● ● ● ● ● | 130,00 |



Carro contenedor de basura
Tapa abatible con pedal.

| Ref. | Medidas | Capacidad | Color | Euros |
|-------|------------------|-----------|-------|--------|
| W-240 | 74 x 58 x 107 cm | 240 l | ● ● | 175,00 |



**Cubos de basura reciclables con pedal
Con aro sujeta bolsas 25l.**

| Ref. | Medidas | Color | Euros |
|---------|-------------------|-------|-------|
| W-25-B | 39,5 x 27 x 42 cm | • | 32,00 |
| W-25-A | 39,5 x 27 x 42 cm | • | 32,00 |
| W-25-AZ | 39,5 x 27 x 42 cm | • | 32,00 |
| W-25-M | 39,5 x 27 x 42 cm | • | 32,00 |
| W-25-V | 39,5 x 27 x 42 cm | • | 32,00 |



**Cubos de basura reciclables con pedal
Con aro sujeta bolsas 40l.**

| Ref. | Medidas | Color | Euros |
|---------|-------------------|-------|-------|
| W-40-B | 39,5 x 35 x 47 cm | • | 42,00 |
| W-40-A | 39,5 x 35 x 47 cm | • | 42,00 |
| W-40-AZ | 39,5 x 35 x 47 cm | • | 42,00 |
| W-40-M | 39,5 x 35 x 47 cm | • | 42,00 |
| W-40-V | 39,5 x 35 x 47 cm | • | 42,00 |



Papelera basculante acero-inox
Tapa basculante. Parte superior extraible

| Ref. | Medidas | Capacidad | Euros |
|-------|-----------------|-----------|--------|
| WI-35 | 30 x 20 x 70 cm | 35 l | 285,00 |



Papelera basculante acero-inox
Tapa basculante.
Parte superior extraible

| Ref. | Medidas | Capacidad | Euros |
|-------|-----------------|-----------|--------|
| WI-75 | 40 x 30 x 90 cm | 75 l | 310,00 |



Contenedor acero-inox
Tapa con pedal.
Puerta frontal para extraer bolsa.
Asa H72

| Ref. | Medidas | Capacidad | Euros |
|-------|-----------------|-----------|--------|
| WI-70 | 46 x 36 x 72 cm | 70 l | 425,00 |



Contenedor acero-inox
Tapa con pedal.
Puerta frontal para extraer bolsa.
Asa H92

| Ref. | Medidas | Capacidad | Euros |
|-------|-----------------|-----------|--------|
| WI-90 | 46 x 36 x 92 cm | 90 l | 490,00 |



Contenedor acero-inox
Tapa con pedal

| Ref. | Diámetro | Altura | Capacidad | Euros |
|--------|----------|--------|-----------|--------|
| WI-110 | Ø 40 cm | 86 cm | 110 l | 315,00 |



Contenedor acero-inox
Tapa con pedal. Tapa extraíble

| Ref. | Diámetro | Altura | Capacidad | Euros |
|-------|----------|--------|-----------|--------|
| WI-60 | Ø 40 cm | 60 cm | 60 l | 385,00 |



6

Indicadores de turno

Reloj-temperatura

Expendedores de tickets

Rollo tickets

Exterminadores de insectos

Detector contador billetes - monedas



Indicador su turno (SÓLO PANTALLA)
Visor 2 dígitos **PERSONALIZABLE**

| Ref. | Medidas | Altura dígitos (cm) | Voltaje (V) | Euros |
|------------|--------------|---------------------|-------------|--------|
| IT-6- MAXI | 24,5 x 15 cm | 9,5 | 110V - 220V | 280,00 |

Equipo **MULTIFUNCIÓN** con opción mando cable, mando a distancia, mando a visión o mandos estancos.
Máster y repetidor. Añade más pantallas si necesitas.
Opción con conexión a balanza.
Carcasa ABS negra.
Dígitos con posibilidad de elección entre 9 colores.

Mandos, pulsadores y conexiones para **IT-6-MAXI**.
Suma lo que necesites al precio de la pantalla

| | Pulsador mando cable 1 función | <table border="1"> <thead> <tr> <th>Ref.</th> <th>Euros</th> </tr> </thead> <tbody> <tr> <td>IT- 103-1F</td> <td>45,00</td> </tr> </tbody> </table> | Ref. | Euros | IT- 103-1F | 45,00 | Pulsador mando a distancia ESTANCO 1 función | <table border="1"> <thead> <tr> <th>Ref.</th> <th>Euros</th> </tr> </thead> <tbody> <tr> <td>IT-106-E</td> <td>105,00</td> </tr> </tbody> </table> | Ref. | Euros | IT-106-E | 105,00 |
|------------|--|---|------|-------|------------|--------|---|--|------|-------|----------|--------|
| Ref. | Euros | | | | | | | | | | | |
| IT- 103-1F | 45,00 | | | | | | | | | | | |
| Ref. | Euros | | | | | | | | | | | |
| IT-106-E | 105,00 | | | | | | | | | | | |
| | Pulsador mando cable 1 función ESTANCO. | <table border="1"> <thead> <tr> <th>Ref.</th> <th>Euros</th> </tr> </thead> <tbody> <tr> <td>IT-103-E</td> <td>65,00</td> </tr> </tbody> </table> | Ref. | Euros | IT-103-E | 65,00 | Cable conexión a balanza Dibal 3 metros | <table border="1"> <thead> <tr> <th>Ref.</th> <th>Euros</th> </tr> </thead> <tbody> <tr> <td>IT-120-B</td> <td>30,00</td> </tr> </tbody> </table> | Ref. | Euros | IT-120-B | 30,00 |
| Ref. | Euros | | | | | | | | | | | |
| IT-103-E | 65,00 | | | | | | | | | | | |
| Ref. | Euros | | | | | | | | | | | |
| IT-120-B | 30,00 | | | | | | | | | | | |
| | Pulsador mando cable a visión | <table border="1"> <thead> <tr> <th>Ref.</th> <th>Euros</th> </tr> </thead> <tbody> <tr> <td>IT-121</td> <td>125,00</td> </tr> </tbody> </table> | Ref. | Euros | IT-121 | 125,00 | Cable conexión a mando cable | <table border="1"> <thead> <tr> <th>Ref.</th> <th>Euros</th> </tr> </thead> <tbody> <tr> <td>IT-120</td> <td>30,00</td> </tr> </tbody> </table> | Ref. | Euros | IT-120 | 30,00 |
| Ref. | Euros | | | | | | | | | | | |
| IT-121 | 125,00 | | | | | | | | | | | |
| Ref. | Euros | | | | | | | | | | | |
| IT-120 | 30,00 | | | | | | | | | | | |
| | Pulsador mando a distancia 4 funciones | <table border="1"> <thead> <tr> <th>Ref.</th> <th>Euros</th> </tr> </thead> <tbody> <tr> <td>IT-106-4</td> <td>66,00</td> </tr> </tbody> </table> | Ref. | Euros | IT-106-4 | 66,00 | Cable conexión a batería 12 V | <table border="1"> <thead> <tr> <th>Ref.</th> <th>Euros</th> </tr> </thead> <tbody> <tr> <td>IT-120-V</td> <td>30,00</td> </tr> </tbody> </table> | Ref. | Euros | IT-120-V | 30,00 |
| Ref. | Euros | | | | | | | | | | | |
| IT-106-4 | 66,00 | | | | | | | | | | | |
| Ref. | Euros | | | | | | | | | | | |
| IT-120-V | 30,00 | | | | | | | | | | | |



OPCIÓN MONTAJE CARCASA VARIOS COLORES 35,00 EUROS



Indicador de turno
Visor dos dígitos. Mando con cable de 2 funciones.

| Ref. | Medidas | Altura dígitos (cm) | Voltaje (V) | Euros |
|------|--------------|---------------------|-------------|--------|
| IT-8 | 24,5 x 15 cm | 9.5 | 110V - 220V | 205,00 |



Indicador de turno
Visor dos dígitos. Mando a distancia de 2 funciones.

| Ref. | Medidas | Altura dígitos (cm) | Voltaje (V) | Euros |
|---------|--------------|---------------------|-------------|--------|
| IT-8-MD | 24,5 x 15 cm | 9.50 | 110V - 220V | 205,00 |



Indicador de turno
Visor de dos dígitos con mando pulsador con cable de 1 función

| Ref. | Medidas | Altura dígitos (cm) | Voltaje (V) | Euros |
|----------|--------------|---------------------|-------------|--------|
| IT-6-ECO | 34,5 x 24 cm | 12.5 | 220V | 275,00 |



Indicador de turno
Visor dos dígitos con mando a distancia de 1 función.

| Ref. | Medidas | Altura dígitos (cm) | Voltaje (V) | Euros |
|-------------|--------------|---------------------|-------------|--------|
| IT-6-MD-ECO | 34,5 x 24 cm | 12.5 | 220 | 230,00 |



Indicador de turno
Visor de dos dígitos con mando a distancia.

| Ref. | Medidas | Altura dígitos (cm) | Voltaje (V) | Euros |
|---------|------------|---------------------|-------------|--------|
| IT-5-MD | 30 x 26 cm | 13 | 220 | 260,00 |



Indicador de turno
Visor de dos dígitos y mando a distancia con visor.

| Ref. | Medidas | Altura dígitos (cm) | Voltaje (V) | Euros |
|----------|------------|---------------------|-------------|--------|
| IT-5-MDV | 30 x 32 cm | 13 | 220 | 280,00 |



Indicador de turno. Visor 2 dígitos. Mando a distancia.
Kit: pantalla + mando + dispensador rojo + 1 rollo + cartel

| Ref. | Medidas | Altura dígitos (cm) | Voltaje (V) | Euros |
|---------|------------|---------------------|-------------|--------|
| IT-9-MD | 30 x 20 cm | 10 | 220 V | 235,00 |



Indicador de turno
Batería 12v. Visor dos dígitos. Mando a distancia

| Ref. | Medidas | Voltaje (V) | Altura dígitos (cm) | Euros |
|---------|--------------|-------------|---------------------|--------|
| IT-7-MD | 28 x 24,5 cm | 220V/12V | 15 | 245,00 |



Indicador de turno
Panel 3 secciones. Visor 2+4 dígitos. Mando con cable.

| Ref. | Medidas | Altura dígitos (cm) | Voltaje (V) | Euros |
|-------|------------|---------------------|-------------|--------|
| IT-30 | 54 x 40 cm | 12,5 + 9,5 | 220 | 909,00 |



Indicador de turno
Panel de 3 secciones. Visor 2+4 dígitos. Mando a distancia.

| Ref. | Medidas | Altura dígitos (cm) | Voltaje (V) | Euros |
|----------|------------|---------------------|-------------|--------|
| IT-30-MD | 54 x 40 cm | 12,5 x 9,5 | 220 | 909,00 |



Reloj - temperatura
Carcasa metálica. 4 dígitos 12,5 rojos. Mando a distancia

| Ref. | Medidas | Euros |
|---------|----------------|--------|
| ITR-125 | 63,5 x 30,5 cm | 848,00 |



Expendedor de tickets

| Ref. | Color | Euros |
|---------|-------|-------|
| ET-1-A | ● | 20,00 |
| ET-1-AZ | ● | 20,00 |
| ET-1-B | ○ | 20,00 |
| ET-1-G | ● | 20,00 |
| ET-1-N | ● | 20,00 |
| ET-1-NA | ● | 20,00 |
| ET-1-R | ● | 20,00 |
| ET-1-V | ● | 20,00 |

Rollos tickets dos dígitos (2000 números)

| Ref. | Color | Unidade | Euros |
|---------|-------|---------|-------|
| RT-5-A | ● | 10 | 22,00 |
| RT-5-AZ | ● | 10 | 22,00 |
| RT-5-B | ○ | 10 | 22,00 |
| RT-5-R | ● | 10 | 22,00 |
| RT-5-V | ● | 10 | 22,00 |

Rollos de tickets tres dígitos (2000 números)

| Ref. | Color | Unidade | Euros |
|---------|-------|---------|-------|
| RT-6-A | ● | 10 | 22,00 |
| RT-6-AZ | ● | 10 | 22,00 |
| RT-6-B | ○ | 10 | 22,00 |
| RT-6-R | ● | 10 | 22,00 |
| RT-6-V | ● | 10 | 22,00 |



Columna epoxi negro para expendedor ET-1 no incluido. Incluye cartel.

| Ref. | Altura (cm) | Euros |
|-------|-------------|--------|
| ET-15 | 136 cms | 143,00 |



Columna acero inoxidable para expendedor ET-1 no incluido.

| Ref. | Altura (cm) | Euros |
|-------|-------------|-------|
| ET-10 | 135 cms | 84,00 |



Exterminador de insectos
 Posición suspendido ó sobre su base, material de policarbonato.

| Ref. | Medidas | Voltaje | Tensión rejilla (V) | Tubo luz actínica | Superficie máxima (m ²) | Euros |
|-------|-------------------|------------|---------------------|-------------------|-------------------------------------|-------|
| Z-151 | 13 x 16 x 34,5 cm | 220 V 50Hz | 4000 | 1 x 11 W | 110 | 38,50 |



Exterminador de insectos por descarga eléctrica.
 Con mando a distancia.
 Material aluminio / Abs.
 Posición colgante o sobre su base.
 Bandeja recoge insectos extraíble.
 Interruptor encendido / apagado.

| Ref. | Medidas | Voltaje | Tensión rejilla (V) | Tubo luz actínica | Superficie máxima (m ²) | Euros |
|----------|-----------------|-----------------|---------------------|-------------------|-------------------------------------|--------|
| Z-420-MD | 39 x 30 x 10 cm | 220-240 V | 2500 | 2 x 6,5 W | 80 | 90,00 |
| Z-430-MD | 49 x 34 x 10 cm | 220-240 V 50 HZ | 2500 | 2 x 7 W | 100 | 110,00 |
| Z-440-MD | 64 x 39 x 10 cm | 220-240 V 50 HZ | 2500 | 2 x 10 W | 150 | 130,00 |



Exterminador de insectos por descarga eléctrica con tecnología LED
Construcción en acero inox. 304 / Abs.
Posición suspendido, colgante con cadeneta.
Fácil mantenimiento, pasadores para fácil apertura, sin uso de herramientas.
Bandeja recoge insectos extraíble e interruptor encendido/apagado.

| Ref. | Medidas | Voltaje | Tensión rejilla (V) | Tubo luz actínica LED | Superficie máxima (m²) | Euros |
|--------------|-----------------|--------------|---------------------|-----------------------|------------------------|---------------|
| Z-600 | 39 x 28 x 10 cm | 220V 50/60Hz | 1000 | 2 x 4,5 W LED | 100 | 128,00 |
| Z-700 | 54 x 28 x 10 cm | 220V 50/60Hz | 1000 | 2 x 7 W LED | 150 | 140,00 |
| Z-740 | 69 x 28 x 10 cm | 220 V | 2500 | 2 x 10 W LED | 200 | 175,00 |

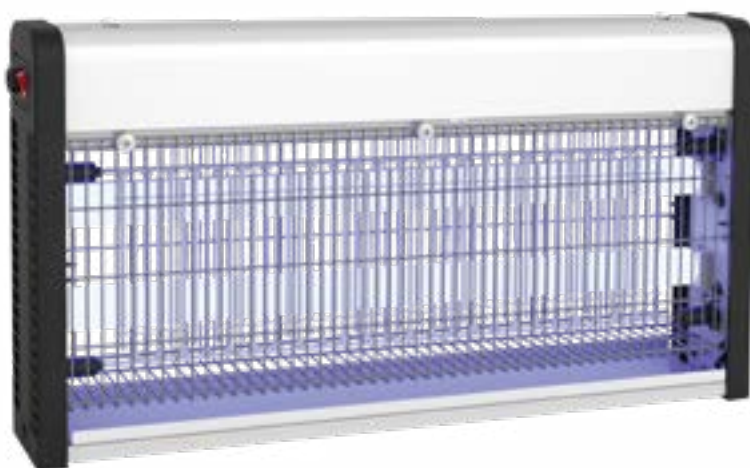

Exterminador de insectos por descarga eléctrica con tecnología LED.
Construcción en aluminio / Abs.
Posición suspendido, colgante con cadeneta.
Interruptor encendido/apagado.

| Ref. | Medidas | Voltaje | Tensión rejilla (V) | Tubo luz actínica | Superficie máxima (m²) | Euros |
|------------------|----------------------|------------|---------------------|-------------------|------------------------|--------------|
| Z-700-ECO | 48,6 x 26,4 x 7,2 cm | 220 V 50Hz | 1000 | 2 X 7 W LED | 150 | 75,00 |



Exterminador de insectos con trampa adhesiva
Acabado en Abs. Blanco o Negro.
Posición mural.
Diseño decorativo.
Fácil mantenimiento.
Lámpara 1x20 W bajo consumo

| Ref. | Color | Medidas | Voltaje | Lámpara luz actínica | Euros |
|---------|-------|----------------|---------|----------------------|-------|
| Z-911 | ● | 39 x 20 x 9 cm | 220 V | 1 x 20 W | 57,00 |
| Z-911-N | ● | 39 x 20 x 9 cm | 220 V | 1 x 20 W | 63,00 |

Lámina adhesiva
Para ref. Z-911.
Paquete 6 unidades

| Ref. | Unidades | Euros |
|---------|----------|-------|
| Z-911-A | 6 | 20,00 |



Exterminador de insectos con trampa adhesiva
Acabado en acero epoxi Blanco o Negro.
Posición mural.
Discreto.
Fácil mantenimiento.
Recambio adhesiva : ref. Z-918-A

| Ref. | Color | Medidas | Voltaje | Lámpara luz actínica | Euros |
|---------|-------|---------------------|---------|----------------------|-------|
| Z-918 | ● | 47 x 18,7 x 15,5 cm | 220 V | 7 W LED | 98,00 |
| Z-918-N | ● | 47 x 18,7 x 15,5 cm | 220 V | 7 W LED | 98,00 |

Lámina adhesiva
Para ref. Z-918.
Paquete 6 unidades

| Ref. | Unidades | Euros |
|---------|----------|-------|
| Z-918-A | 6 | 20,00 |

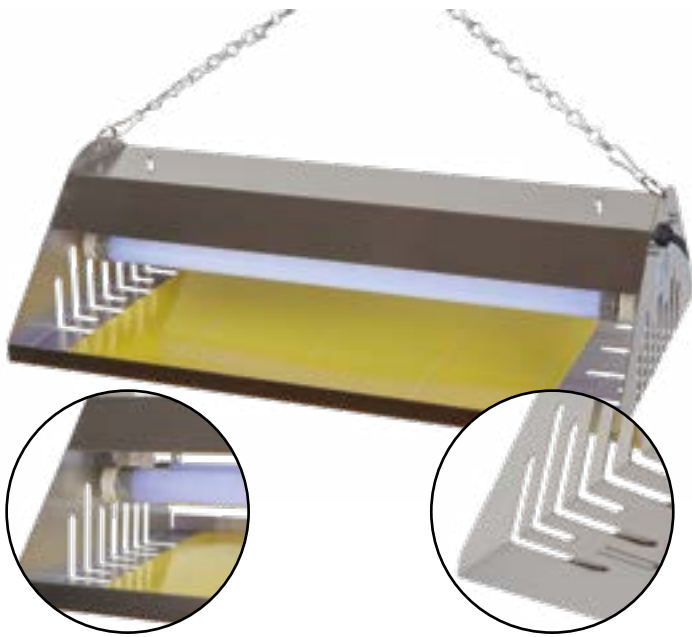

Exterminador de insectos con trampa adhesiva
 Construcción robusta en acero inox. 304.
 Posición colgante o mural.
 Fácil acceso para cambio de trampa adhesiva.
 Lámina adhesiva de alto poder de captación.
 Recambio adhesiva : ref. Z-950-A

| Ref. | Medidas | Voltaje | Tubo luz actínica | Euros |
|-------|---------------------|---------|-------------------|--------|
| Z-950 | 48,5 x 35,5 x 16 cm | 220 | 2 x 15 W | 165,00 |

Lámina adhesiva
 Para ref. Z-950/Z-955.
 Paquete 6 unidades

| Ref. | Unidades | Euros |
|---------|----------|-------|
| Z-950-A | 6 | 32,00 |

Exterminador de insectos con trampa adhesiva.
 Para ambientes con alto nivel de humedad.
 Sistema estanco Ip 65.
 Material acero inox. 304.
 Posición colgante o sobremesa.
 Fácil acceso para cambio de trampa adhesiva
 Lámina adhesiva de alto poder de captación.
 Recambio adhesivo: ref. Z-960-A

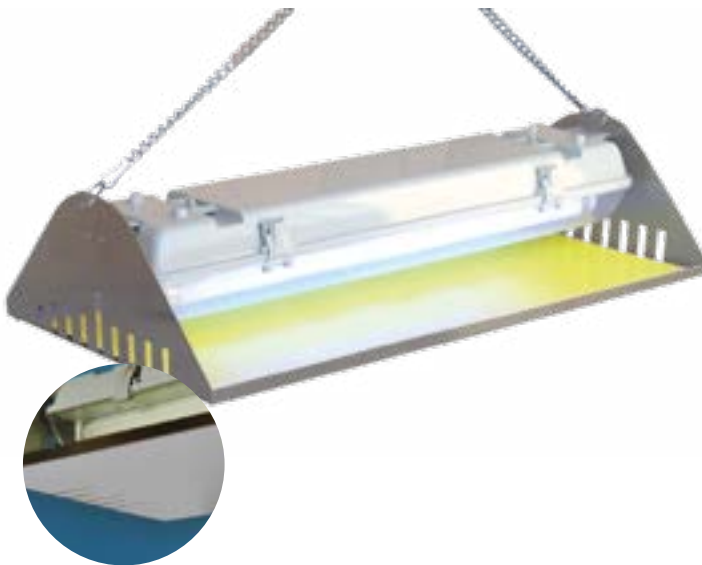

| Ref. | Medidas | Voltaje | Tubo luz actínica | Euros |
|-------|-------------------|---------|-------------------|--------|
| Z-960 | 68 x 32 x 15,5 cm | 220 | 2 x 20 W | 218,00 |

Lámina adhesiva
 Para ref. Z-960.
 Paquete 6 unidades

| Ref. | Unidades | Euros |
|---------|----------|-------|
| Z-960-A | 6 | 34,00 |



Exterminador de insectos con trampa adhesiva dos caras.
 Material aluminio /Abs.
 Posición colgante, sobremesa.
 Gran cobertura, 3 planos.
 Fácil acceso.
 Lámina adhesiva negra, evita qe los insectos puedan ser vistos.
 Recambio adhesivo: Z-931-A

| Ref. | Medidas | Voltaje | Tubo luz actínica | Euros |
|-------|----------------|---------|-------------------|--------|
| Z-931 | 58 x 26 x 9 cm | 220 V | 4 x 7 W LED | 135,00 |

Lámina adhesiva
 Para ref. Z-931.
 Paquete 6 unidades

| Ref. | Unidades | Euros |
|---------|----------|-------|
| Z-931-A | 6 | 27,00 |

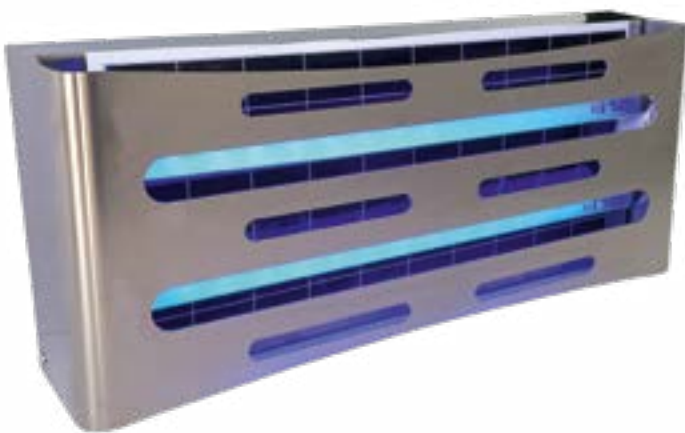

Exterminador de insectos con tecnología LED
 Material de acero inox. 304.
 Posición mural.
 Lámina adhesiva negra, evita que los insectos puedan ser vistos.
 Recambio adhesivo: Z-940-A

| Ref. | Medidas | Voltaje | Tubo luz actínica | Euros |
|-------|-----------------|---------|-------------------|--------|
| Z-940 | 51 X 21 X 13 cm | 220 | 4 x 7 W LED | 180,00 |

Lámina adhesiva
 Para ref.: z-940
 Paquete 6 unidades

| Ref. | Unidades | Euros |
|---------|----------|-------|
| Z-940-A | 6 | 25,00 |

6 DETECTOR CONTADOR BILLETES - MONEDAS



Detector de billetes electrónico arrastre automático, batería

| Ref. | Voltaje (V) | Euros |
|-------|-------------|--------|
| A-530 | 220 V | 190,00 |

Detector de billetes electrónico arrastre automático

| Ref. | Voltaje (V) | Euros |
|-------|-------------|--------|
| A-531 | 220 V | 170,00 |



Contador separador monedas EURO

| Ref. | Voltaje (V) | Euros |
|-------|-------------|--------|
| A-540 | 220 V | 398,00 |



Detector contador billetes distinto valor EURO

| Ref. | Voltaje (V) | Euros |
|-------|-------------|--------|
| A-550 | 220 V | 895,00 |



Detector contador billetes igual valor EURO

| Ref. | Voltaje (V) | Euros |
|-------|-------------|--------|
| A-555 | 220 V | 399,00 |

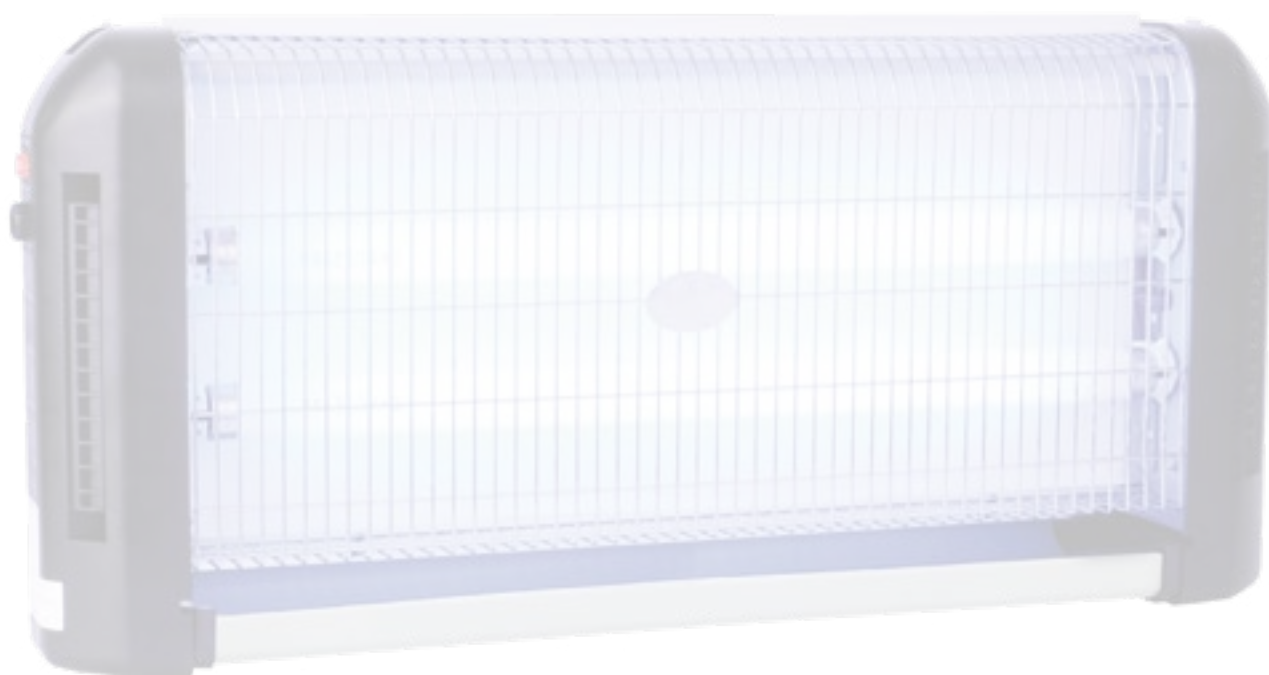



7

Hamburgueseras

Papel celofán y separador interloncheado

Embutidoras

Sujeta jamones

Jamonero rotatorio 360°

Cono y calas

Ganchos

Libradores

Pinzas

Porta notas

Porta rollo

Soporte para pinchar tickets

Máquina y molde para brochetas

Enternecedor de carne

Mallas y anillas elásticas

Tubos para enmallar rellenos

Protector hueso

Termómetros

131 - 145



Máquina hamburguesa semi-automática
 Molde de acero inox 1 unidad.
 Tipo papel celofán ref. PH-6.
 Contenedor para papel celofán incorporado.
 Funcionamiento: mediante brazo de mando que permite de modo sincronizado la compresión y extracción de la hamburguesa.

| Ref. | Diámetro | Euros |
|-------|----------|--------|
| MH-10 | Ø 10 cm | 455,00 |



Máquina hamburguesa semi-automática
 Molde de acero inox 1 unidad
 Tipo papel celofán ref. PH-7.
 Contenedor para papel celofán incorporado.
 Funcionamiento: mediante brazo de mando que permite de modo sincronizado la compresión y extracción de la hamburguesa.

| Ref. | Diámetro | Euros |
|-------|----------|--------|
| MH-13 | Ø 13 cm | 480,00 |



Máquina hamburguesa semi-automática
 Molde de acero inox 1 unidad.
 Tipo papel celofán ref. PH-8.
 Contenedor para papel celofán incorporado.
 Funcionamiento: mediante brazo de mando que permite de modo sincronizado la compresión y extracción de la hamburguesa.

| Ref. | Diámetro | Euros |
|-------|----------|--------|
| MH-15 | Ø 15 cm | 520,00 |



Hamburguesera carcasa aluminio de 1 unidad ovalada 11x8

| Ref. | Diámetro | Euros |
|------|--------------|-------|
| MH-1 | Oval 11x8 cm | 70,00 |

Hamburguesera aluminio 1 unidad redonda Ø 10 cm

| Ref. | Diámetro | Euros |
|--------|----------|-------|
| MH-1-R | Ø 10 cm | 75,00 |



Molde 1 unidad redonda con expulsor hamburguesa ACERO-INOX.

| Ref. | Diámetro | Euros |
|-------|----------|--------|
| MH-25 | Ø 5 cm | 95,00 |
| MH-20 | Ø 6,5 cm | 95,00 |
| MH-21 | Ø 10 cm | 99,00 |
| MH-22 | Ø 13 cm | 125,00 |
| MH-23 | Ø 15 cm | 140,00 |



Hamburguesera de 1 unidad Ø 13 cm

| Ref. | Diámetro | Euros |
|------|----------|--------|
| MH-6 | Ø 13 cm | 305,00 |



Paquete papel celofán redondo BIODEGRADABLE Y COMPOSTABLE

| Ref. | Diámetro | Unidades | Euros |
|------|----------------|----------|-------|
| PH-3 | Ø 5 cm | 900 | 6,00 |
| PH-4 | Ø 6,5 cm | 450 | 3,80 |
| PH-6 | Ø 10 cm | 350 | 5,60 |
| PH-5 | OVAL 11 x 8 cm | 450 | 4,80 |
| PH-7 | Ø 13 cm | 350 | 10,50 |
| PH-8 | Ø 15 cm | 350 | 13,50 |



Separador Interloncheados

| Ref. | Medidas | Unidades | Euros |
|-------|-------------|----------|-------|
| PS-60 | 160 x 60 mm | 500 | 7,50 |
| PS-70 | 160 x 70 mm | 500 | 8,50 |
| PS-80 | 160 x 80 mm | 500 | 9,50 |

7 HAMBURUESERAS 2 Y 4 MOLDES



Hamburguesa carcasa aluminio de 2 unidades ovalada 11x8

| Ref. | Diámetro | Euros |
|------|----------------|--------|
| MH-2 | OVAL 11 x 8 cm | 240,00 |



Hamburguesa aluminio 2 unidades. Redonda Ø 10 cm

| Ref. | Diámetro | Euros |
|------|----------|--------|
| MH-8 | Ø 10 cm | 270,00 |



Hamburguesa aluminio 2 unidades. Redonda Ø 6,5 cm

| Ref. | Diámetro | Euros |
|------|----------|--------|
| MH-9 | Ø 6,5 cm | 270,00 |



Hamburguesa acero-inox de 2 unidades ovalada 11x8 cm

| Ref. | Diámetro | Euros |
|------|----------------|--------|
| MH-3 | OVAL 11 X 8 cm | 315,00 |



Hamburguesa acero-inox de 2 unidades redonda Ø 10 cm

| Ref. | Diámetro | Euros |
|------|----------|--------|
| MH-5 | Ø 10 cm | 305,00 |



Hamburguesa acero-inox de 2 unidades redonda Ø 13 cm

| Ref. | Diámetro | Euros |
|------|----------|--------|
| MH-7 | Ø 13 cm | 385,00 |

HAMBURUESERA 4 MOLDES



Hamburguesa acero-inox de 4 unidades ovalada 11x8

| Ref. | Diámetro | Euros |
|------|----------------|--------|
| MH-4 | OVAL 11 x 8 cm | 369,00 |



Embutidoras inox

| Ref. | Medidas | Capacidad | Euros |
|--------|-------------------|-----------|--------|
| ME-L5 | 55 x 19 x 21,5 cm | 5 kg | 385,00 |
| ME-L8 | 65 x 19 x 21,5 cm | 8 kg | 410,00 |
| ME-L8V | 30 x 32 x 79 cm | 8 kg | 495,00 |



Embutidoras inox

| Ref. | Medidas | Peso | Capacidad | Euros |
|--------|-----------------|-------|-----------|---------|
| ME-L7 | 69 x 24 x 24 cm | 27 kg | 7 l | 1150,00 |
| ME-L14 | 84 x 28 x 29 cm | 35 kg | 14 l | 1405,00 |

Despiece

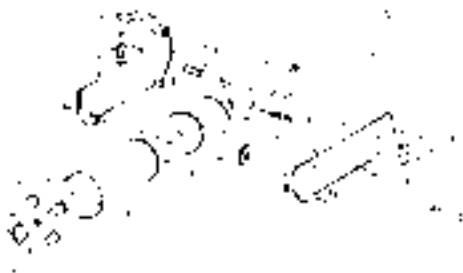

Medidas

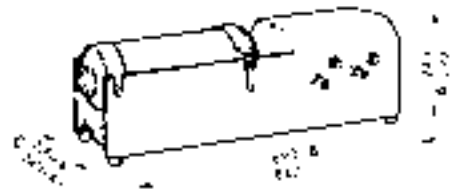

Juego 4 embudos inyección embutidora

| Ref. | Euros |
|------|-------|
| A-37 | 29,00 |



Sujeta jamones
Rústico, base madera

| Ref. | Euros |
|------|-------|
| SJ-4 | 82,00 |



Sujeta jamones
Fijo soporte madera

| Ref. | Euros |
|------|-------|
| SJ-9 | 37,50 |



Sujeta jamones
Articulado giratorio inox base madera

| Ref. | Euros |
|-------|--------|
| SJ-10 | 196,00 |



Sujeta jamones giratorio 360° inox
base madera

| Ref. | Euros |
|-------|--------|
| SJ-18 | 467,00 |



Sujeta jamón
Sobremesa o pared - base polietileno

| Ref. | Euros |
|--------|--------|
| SJ-5-M | 112,00 |



Sujeta jamones
Base y brazo polietileno blanco

| Ref. | Euros |
|--------|-------|
| SJ-6-B | 56,00 |



Sujeta jamones
Acero inox, soporte regulable

| Ref. | Euros |
|------|--------|
| SJ-8 | 148,00 |



Sujeta jamones
Articulado giratorio 360° inox
Base de polietileno negro

| Ref. | Euros |
|-------|--------|
| SJ-16 | 450,00 |



Mesa jamonera con soporte jamón inox
giratorio 360°
Encimera madera con dos estantes

| Ref. | Medidas | Euros |
|--------|-----------------|--------|
| SJ-600 | 60 x 50 x 85 cm | 785,00 |

Mesa jamonera con soporte jamón inox
giratorio 360°
Encimera madera con dos estantes y dos
ruedas giratorias con freno.

| Ref. | Medidas | Euros |
|----------|-----------------|--------|
| SJ-600-R | 60 x 50 x 85 cm | 822,00 |



Cono escurrejamonos

| Ref. | Unidades | Euros |
|------|----------|-------|
| A-3 | 6 | 9,50 |



Cala jamón hueso de vaca

| Ref. | Euros |
|------|-------|
| A-27 | 24,00 |



Cala jamón mango madera

| Ref. | Euros |
|------|-------|
| A-28 | 19,00 |

GANCHOS ACERO-INOX



Ganchos acero-inox

| Ref. | Largo | Varilla | Unidades | Euros |
|------|-------|---------|----------|-------|
| G-00 | 8 cm | 4 mm | 10 | 7,50 |
| G-0 | 10 cm | 4 mm | 10 | 8,50 |
| G-1 | 12 cm | 5 mm | 10 | 10,50 |
| G-2 | 14 cm | 5 mm | 10 | 11,50 |
| G-3 | 16 cm | 5 mm | 10 | 13,50 |
| G-4 | 18 cm | 5 mm | 10 | 14,50 |
| G-5 | 20 cm | 5 mm | 10 | 18,00 |
| G-6 | 22 cm | 6 mm | 10 | 21,00 |

Ganchos acero-inox

| Ref. | Largo | Varilla | Unidades | Euros |
|------|-------|---------|----------|-------|
| G-7 | 20 cm | 8 mm | 10 | 33,00 |
| G-8 | 30 cm | 8 mm | 10 | 47,00 |
| G-9 | 18 cm | 8 mm | 10 | 31,00 |

Ganchos giratorio acero-inox

| Ref. | Largo | Varilla | Euros |
|------|-------|---------|-------|
| G-10 | 25 cm | 11 mm | 25,00 |
| G-11 | 30 cm | 11 mm | 27,00 |
| G-12 | 25 cm | 12 mm | 16,00 |
| G-13 | 30 cm | 12 mm | 19,00 |



Gancho 4 puntas

| Ref. | Euros |
|------|-------|
| G-14 | 11,00 |



Gancho de pared

| Ref. | Medidas | Euros |
|------|----------|-------|
| G-19 | 120 x 12 | 17,00 |



Gancho salchichero giratorio de 22 cm de altura con 4 brazos de 10 cm.

| Ref. | Euros |
|------|-------|
| G-15 | 41,00 |



Torre pirámide salchichera

| Ref. | Altura | Diámetro | Euros |
|------|--------|----------|-------|
| G-20 | 39 cm | Ø 28 cm | 59,00 |

7 LIBRADORES-COGEDORES



Librador - cogedor, inox

| Ref. | Medidas | Euros |
|--------|-----------------|-------|
| A-5-12 | 21 / 12 x 6 cm | 16,00 |
| A-5-16 | 25 / 16 x 9 cm | 17,50 |
| A-5-20 | 29 / 18 x 10 cm | 22,00 |
| A-5-24 | 31 / 20 x 11 cm | 26,50 |



Librador - cogedor inyectado

| Ref. | Medidas | Euros |
|--------|-----------------|-------|
| A-4-11 | 18 / 12 x 6 cm | 3,35 |
| A-4-14 | 24 / 16 x 8 cm | 3,75 |
| A-4-16 | 28 / 19 x 10 cm | 4,60 |
| A-4-20 | 33 / 22 x 11 cm | 5,80 |
| A-4-24 | 38 / 26 x 13 cm | 6,95 |

PINZAS



Pinza acero-inox con muelle

| Ref. | Euros |
|------|-------|
| A-8 | 3,75 |



Pinza acero-inox

| Ref. | Largo | Euros |
|------|-------|-------|
| A-24 | 24 cm | 19,00 |



Pinza acero-inox con anillas

| Ref. | Euros |
|------|-------|
| A-26 | 14,00 |



Pinza acero-inox para embutido

| Ref. | Euros |
|------|-------|
| A-20 | 7,00 |



Pinza acero-inox espina pescado

| Ref. | Euros |
|------|-------|
| A-23 | 9,00 |

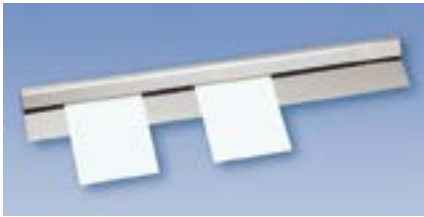

Porta-notas acero-inox, 60 cm con bolitas

| Ref. | Euros |
|-------|-------|
| T-360 | 29,00 |



Soporte para pinchar tickets

| Ref. | Euros |
|-------|-------|
| PR-25 | 14,00 |



Porta rollo hilo

| Ref. | Euros |
|-------|--------|
| PR-20 | 106,00 |

MÁQUINA MANUAL PINCHOS



Máquina manual pinchos acero inox 2 unidades

| Ref. | Euros |
|------|--------|
| A-49 | 380,00 |

MOLDE BROCHETAS. PALILLOS



Molde brochetas polietileno para 25 unidades

| Ref. | Medidas | Euros |
|------|---------------------|--------|
| A-50 | 16,5 x 16,5 x 31 cm | 155,00 |



Palillos

| Ref. | Largo | Unidades | Euros |
|---------|-------|----------|-------|
| A-50-15 | 15 cm | 200 | 1,60 |
| A-50-25 | 25 cm | 100 | 1,70 |
| A-50-30 | 30 cm | 100 | 2,10 |



Enternecedor carne minibla

| Ref. | Euros |
|------|-------|
| A-15 | 65,00 |

MALLAS Y ANILLAS ELÁSTICAS



Malla elástica. Máximo 175°

| Ref. | Tipo | Largo | Euros |
|--------|------|-------|-------|
| H-12SR | 12 | 50 m | 11,50 |
| H-14SR | 14 | 50 m | 12,75 |
| H-16SR | 16 | 50 m | 13,50 |
| H-18SR | 18 | 50 m | 14,50 |
| H-20SR | 20 | 50 m | 16,00 |
| H-22R | 22 | 50 m | 22,50 |
| H-24R | 24 | 50 m | 23,75 |
| H-26R | 26 | 50 m | 26,00 |
| H-28R | 28 | 50 m | 28,00 |

TUBOS DE PLÁSTICO



Anillas elásticas

| Ref. | Tipo | Peso | Euros |
|---------|------|------|-------|
| H-120NV | 120 | 3 kg | 87,00 |
| H-140NV | 140 | 3 kg | 87,00 |

Tubo plastico naranja

| Ref. | Tipo | Euros | Ref. | Tipo | Euros |
|-------|--------|-------|-------|--------|-------|
| H-E10 | 10/86 | 43,00 | H-E16 | 16/125 | 45,00 |
| H-E12 | 12/92 | 43,00 | H-E18 | 18/140 | 45,00 |
| H-E14 | 14/110 | 43,00 | | | |



Protector hueso

| Ref. | Tipo | Largo | Euros |
|-------|------|-------|--------|
| H-P23 | 23 | 100 m | 82,00 |
| H-P33 | 33 | 100 m | 120,00 |

Protector hueso pre-corte 7,5

| Ref. | Tipo | Largo | Euros |
|---------|------|-------|--------|
| H-P23-C | 23 | 100 m | 84,00 |
| H-P33-C | 33 | 100 m | 123,00 |



Termómetro para frigorífico o congelador vertical (-50+50°C)
Con gancho.
Con líquido azul.

| Ref. | Euros |
|-------|-------|
| T-002 | 5,00 |



Termómetro frigorífico (-50 +50°)
Sin mercurio.
Con funda blanca de polipropileno alimentaria que se puede esterilizar.

| Ref. | Euros |
|-------|-------|
| T-050 | 16,00 |



Termómetro digital para frigorífico o congelador con sonda (-50-70°)
Funciones máxima y mínima y alarmas.
Alarma programable que se para sólo si se la apaga.
Cable de 100 cm.
Instrucciones en diferentes idiomas.

| Ref. | Euros |
|-------|-------|
| T-009 | 32,00 |



Termómetro digital horno con sonda (0-300°)
Dispone de medición en grados Fahrenheit de 32 a 572°F

| Ref. | Euros |
|-------|-------|
| T-003 | 66,00 |



Termómetro asado con pincho (+54+88°)
Para carnes.
Sonda de acero inox.

| Ref. | Euros |
|-------|-------|
| T-005 | 21,00 |



Termómetro aceite con gancho (0-300°)

| Ref. | Euros |
|-------|-------|
| T-007 | 19,50 |



Termómetro láser de bolsillo (-50+300°)

| Ref. | Euros |
|-------|-------|
| T-012 | 85,00 |



Termómetro láser modelo extra (-50+280°)

| Ref. | Euros |
|-------|-------|
| T-008 | 99,00 |



Testador de aceite (Pack 10 und.)
Mide el % de Compuestos Polares.

| Ref. | Euros |
|--------|-------|
| TA-002 | 38,00 |



8

Cierra bolsas - rollos

Etiquetadoras-rollos

Naveteadoras

Carros de servicio

Carros bandejeros - plegables - Gastronorm

Cestos - carros autoservicio

Dispensadores bolsas

Guantes y papelera



Máquina cierra bolsas acero inox
Con cuchilla para cortar bolsa

| Ref. | Euros |
|--------|-------|
| CB-101 | 31,00 |



Rollo de PVC 66 x 12

| Ref. | Color | Unidades | Euros |
|---------|-------|----------|-------|
| RB-4-B | ○ | 24 | 59,00 |
| RB-4-A | ● | 24 | 59,00 |
| RB-4-AZ | ● | 24 | 59,00 |
| RB-4-R | ● | 24 | 59,00 |
| RB-4-V | ● | 24 | 59,00 |
| RB-4-T | ⊕ | 24 | 59,00 |



Dispensador celo inyección para referencias RB-4

| Ref. | Euros |
|--------|-------|
| CB-800 | 12,00 |



Etiquetadora una línea 8 dígitos

| Ref. | Euros |
|------|-------|
| E-4 | 95,00 |



Etiquetadora una línea 6 dígitos

| Ref. | Euros |
|------|-------|
| E-5 | 80,00 |



Etiquetadora una línea 6 dígitos

| Ref. | Euros |
|---------|-------|
| E-5-ECO | 55,00 |



Etiquetadora dos líneas 8 dígitos

| Ref. | Euros |
|------|--------|
| E-6 | 145,00 |



Etiquetadora dos líneas 8 dígitos

| Ref. | Euros |
|---------|-------|
| E-6-ECO | 95,00 |

Rodillo tinta

| Ref. | Para | Euros |
|-------|---------------|-------|
| E-110 | E-4, E-5, E-6 | 6,00 |

Rodillo tinta

| Ref. | Para | Euros |
|-----------|------------------|-------|
| E-110-ECO | E-5-ECO, E-6-ECO | 6,00 |

ROLLOS ETIQUETADORAS

Rollos etiquetas

| Ref. | Medidas | Color | Tipo | Unidades | Euros |
|--------|------------|-------|------|----------|-------|
| RE-5-B | 26 x 12 mm | ○ | 1 | 8 | 12,00 |
| RE-5-N | 26 x 12 mm | ● | 1 | 8 | 17,00 |
| RE-6-B | 26 x 16 mm | ○ | 2 | 8 | 12,00 |
| RE-6-N | 26 x 16 mm | ● | 2 | 8 | 17,00 |

Rollo etiquetas dos líneas lote-caducidad

| Ref. | Medidas | Unidades | Euros |
|------|------------|----------|-------|
| RE-7 | 26 x 16 mm | 8 | 14,00 |

Rollos etiquetas dos líneas fecha envasado-fecha caducidad

| Ref. | Medidas | Unidades | Euros |
|------|------------|----------|-------|
| RE-8 | 26 x 16 mm | 8 | 14,00 |





Navet cárnico homologado 25 mm caja 5000 unidades

| Ref. | Unidades | Euros |
|------|----------|-------|
| N-20 | 5000 | 51,00 |

Naveteadora Dennison homologada

| Ref. | Euros |
|------|-------|
| N-3 | 58,00 |

Aguja Dennison homologada 5 unidades

| Ref. | Unidades | Euros |
|------|----------|-------|
| N-31 | 5 | 75,00 |



Navet cárnico standard 25 mm caja 10.000 unidades

| Ref. | Unidades | Euros |
|------|----------|-------|
| N-21 | 10000 | 41,00 |

Naveteadora Arrow standard

| Ref. | Euros |
|------|-------|
| N-9 | 19,00 |



Navet P.P. blanco caja 5.000 unidades

| Ref. | Unidades | Euros |
|------|----------|-------|
| N-22 | 5000 | 10,00 |

Aguja Dennison standard 5 unidades

| Ref. | Unidades | Euros |
|------|----------|-------|
| N-30 | 5 | 15,00 |

Aguja arrow standard 5 unidades

| Ref. | Unidades | Euros |
|------|----------|-------|
| N-32 | 5 | 15,00 |

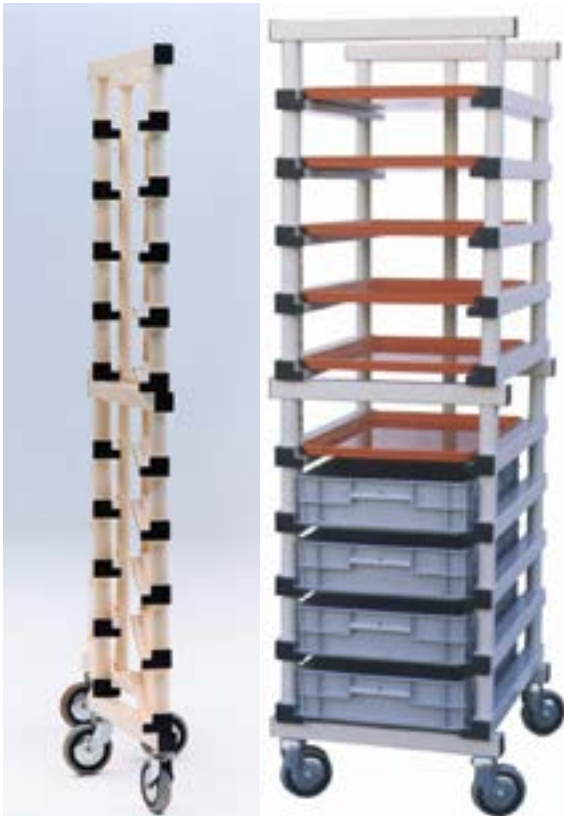

Carro bandejero plegable
 Plegable: 10 guías.
 2 ruedas giratorias.
 2 ruedas giratorias con stop.
 Ruedas cincadas.
 Ideal para bandeja BI-15 ó
 cubeta CC-9/19/21

| Ref. | Medidas | Color | Euros |
|---------|------------------|-------|--------|
| R-10-G | 54 x 65 x 179 cm | ● | 835,00 |
| R-10-BE | 54 x 65 x 179 cm | ○ | 835,00 |

Carro bandejero plegable
 Plegable: 10 guías.
 2 ruedas giratorias.
 2 ruedas giratorias con stop.
 Ruedas poliamida.
 Ideal para bandeja BI-15 ó
 cubeta CC-9/19/21

| Ref. | Medidas | Color | Euros |
|----------|------------------|-------|--------|
| R-10-GP | 54 x 65 x 179 cm | ● | 915,00 |
| R-10-BEP | 54 x 65 x 179 cm | ○ | 915,00 |



Carro bandejero inox
 20 guías.
 2 ruedas giratorias.
 2 ruedas giratorias con stop.
 Incluido ruedas.
 Embalaje desmontado.
 Para bandeja BI-15 60 x 40 cm

| Ref. | Medidas | Euros |
|------|--------------------|--------|
| R-20 | 46,5 x 63 x 186 cm | 385,00 |

Carro bandejero Gastronorm inox 1/1
 20 guías.
 2 ruedas giratorias.
 2 ruedas giratorias con stop.
 Ruedas incluidas.
 Embalaje desmontado.
 Para bandeja 1/1 53 x 32.5 cm

| Ref. | Medidas | Euros |
|------|------------------|--------|
| R-21 | 38 x 55 x 186 cm | 395,00 |

Carro bandejero Gastronorm 2/1
 20 guías.
 2 ruedas giratorias.
 2 ruedas giratorias con stop.
 Ruedas incluidas.
 Embalaje desmontado.
 Para bandeja 2/1 65 x 53 cm

| Ref. | Medidas | Euros |
|------|----------------------|--------|
| R-22 | 58,5 x 67,5 x 186 cm | 405,00 |



Carro de servicio, acero-inox
2 estanterías.
Ruedas: 2 giratorias, 2 giratorias con stop.
Embalaje: desmontado. 40 kgs por estante

| Ref. | Medidas | Euros |
|------|-----------------|--------|
| R-30 | 91 x 59 x 93 cm | 260,00 |



Carro de servicio, acero-inox
3 estanterías.
Ruedas: 2 giratorias, 2 giratorias con stop.
Embalaje: desmontado. 40 kgs por estante

| Ref. | Medidas | Euros |
|------|-----------------|--------|
| R-31 | 91 x 59 x 93 cm | 298,00 |



Bandejas ABS para carros R-10/R-20

| Ref. | Medidas | Color | Euros |
|---------|--------------------|-------|-------|
| BI-15-B | 58,5 x 41 x 2,5 cm | ○ | 21,00 |
| BI-15-R | 58,5 x 41 x 2,5 cm | ● | 21,00 |
| BI-15-N | 58,5 x 41 x 2,5 cm | ● | 21,00 |



Bandejas Pasteleras Acero Inox. / Aluminio

| Ref. | Medidas | Euros |
|-------|----------------|-------|
| BAC-1 | 60 x 40 x 1 cm | 39,00 |
| BAC-2 | 40 x 30 x 1 cm | 28,00 |



**Cesto un asa
Alta resistencia.**

| Ref. | Medidas | Capacidad | Color | Euros |
|-----------|---|-----------|-------|-------|
| R-2020-AZ | 47 x 31 x 30 cm | 28 | ● | 15,00 |
| R-2020-R | 47 x 31 x 30 cm | 28 | ● | 15,00 |
| R-2020-V | 47 x 31 x 30 cm | 28 | ● | 15,00 |
| R-2021 | Carrito para apilar y mover R-2020 | | | 80,00 |



**Cesto con 4 ruedas 2 fijas 2 giratorias
Asas abatibles**

| Ref. | Medidas | Color | Capacidad | Euros |
|-----------|-----------------|-------|-----------|-------|
| R-2032-AZ | 50 x 34 x 36 cm | ● | 32 l | 36,00 |
| R-2032-R | 50 x 34 x 36 cm | ● | 32 l | 36,00 |
| R-2032-V | 50 x 34 x 36 cm | ● | 32 l | 36,00 |



**Cesto con 4 ruedas 2 fijas 2 giratorias
Asas abatibles**

| Ref. | Medidas | Color | Capacidad | Euros |
|-----------|-------------------|-------|-----------|-------|
| R-2054-AZ | 55 x 39,5 x 44 cm | ● | 54 l | 44,50 |
| R-2054-R | 55 x 39,5 x 44 cm | ● | 54 l | 44,50 |
| R-2054-V | 55 x 39,5 x 44 cm | ● | 54 l | 44,50 |



Carro autoservicio 80 l

| Ref. | Medidas | Capacidad | Euros |
|------|--------------------|-----------|--------|
| R-80 | 63 x 49,5 x 105 cm | 80 l | 235,00 |



Carro autoservicio 50 l

| Ref. | Medidas | Euros |
|------|-------------------|--------|
| R-50 | 57 x 47 x 91,5 cm | 190,00 |

Carro autoservicio 75 l

| Ref. | Medidas | Euros |
|------|-------------------|--------|
| R-75 | 78 x 51 x 87,6 cm | 238,00 |

Carro autoservicio 100 l

| Ref. | Medidas | Euros |
|-------|----------------------|--------|
| R-100 | 85,5 x 51,5 x 101 cm | 262,00 |



Ejemplo de conjunto dispensador de guantes y bolsas en rollo. Con opción de añadir papelera.

Personaliza y combina el soporte de fijación (MR-105-I) con los 3 elementos (MR-104-I / MR-103-I / A-90) según necesidad. Se venden por separado. Precio de montaje. 35 euros

Dispensador porta guantes inox

| Ref. | Euros |
|----------|-------|
| MR-104-I | 89,00 |

Dispensador para bolsas en rollo de 500 unidades

| Ref. | Euros |
|----------|-------|
| MR-103-I | 97,00 |

Soporte de fijación inox. para réf. MR-103-I/104-I

| Ref. | Euros |
|----------|--------|
| MR-105-I | 145,00 |



Papelera

| Ref. | Medidas | Euros |
|------|-------------------|-------|
| A-90 | 33 x 13 x 27,5 cm | 79,00 |



Dispensador inox. 2 brazos para rollo bolsas

| Ref. | Euros |
|----------|-------|
| MR-119-I | 57,00 |

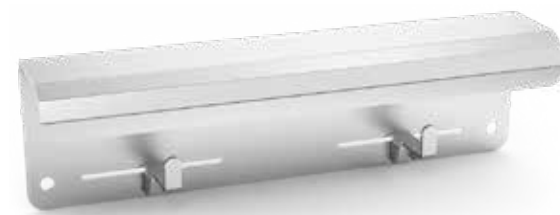

Soporte para bolsas de bloque acero inox. Ganchos móviles

| Ref. | Euros |
|----------|-------|
| MR-115-I | 42,00 |



9

Cuchillería profesional

Imanes

Afiladores

Piedras de afilar

Chairas

Tijeras

Bacaladera

Hachas

Espátulas y paletas

Abre-ostras

Rasqueta

Sierras

Guillotina, lira y rizador de queso

Abrelatas

Guantes

Delantales

155 - 177



**Cuchillo deshuesar
Mango inyectado**

| Ref. | Largo | Color | Euros |
|----------|--------|-----------|-------|
| 0425.130 | 130 mm | ● ● ● ● ● | 12,50 |
| 0425.150 | 150 mm | ● ● ● ● ● | 13,50 |



**Cuchillo deshuesar, hoja curva
Mango inyectado**

| Ref. | Largo | Color | Euros |
|----------|--------|-----------|-------|
| 0430.150 | 150 cm | ● ● ● ● ● | 15,00 |



**Cuchillo carnicero
Mango inyectado**

| Ref. | Largo | Color | Euros |
|----------|--------|-----------|-------|
| 0170.155 | 155 mm | ● ● ● ● ● | 13,50 |
| 0170.185 | 185 mm | ● ● ● ● ● | 15,00 |
| 0170.210 | 210 mm | ● ● ● ● ● | 17,50 |
| 0170.260 | 260 mm | ● ● ● ● ● | 21,00 |
| 0170.310 | 310 mm | ● ● ● ● ● | 27,00 |
| 0170.355 | 355 mm | ● ● ● ● ● | 32,50 |
| 0170.395 | 395 mm | ● | 39,00 |



**Cuchillo carnicero alveolado
Mango inyectado**

| Ref. | Largo | Color | Euros |
|----------|--------|-----------|-------|
| 0151.310 | 310 mm | ● ● ● ● ● | 37,00 |
| 0151.355 | 355 mm | ● ● ● ● ● | 45,00 |
| 0151.395 | 395 mm | ● ● ● ● ● | 54,00 |



Cuchillo cortante tallant

| Ref. | Largo | Color | Euros |
|----------|--------|-----------|-------|
| 0801.230 | 230 mm | ● ● ● ● ● | 45,00 |
| 0801.250 | 250 mm | ● ● ● ● ● | 55,00 |
| 0801.290 | 290 mm | ● ● ● ● ● | 68,00 |



**Cuchillo filetero
Mango inyectado**

| Ref. | Largo | Color | Euros |
|----------|--------|-----------|-------|
| 0901.290 | 290 mm | ● ● ● ● ● | 44,00 |
| 0901.310 | 310 mm | ● ● ● ● ● | 50,00 |
| 0905.290 | 290 mm | ● ● ● ● ● | 48,00 |
| 0905.310 | 310 mm | ● ● ● ● ● | 54,00 |



**Cortante partir
Mango polietileno**

| Ref. | Largo | Color | Euros |
|----------|--------|-------|-------|
| 0840.320 | 320 mm | ● | 52,00 |



**Cuchillo cortante tallant
Cuchillo carnicero M/inox**

| Ref. | Largo | Peso | Euros |
|----------|--------|---------|--------|
| 0850.220 | 220 mm | 1250 gr | 110,00 |
| 0850.250 | 250 mm | 1500 gr | 130,00 |



**Cuchillo cortante tallant
Cuchillo carnicero M/polietileno**

| Ref. | Largo | Peso | Color | Euros |
|----------|--------|---------|-------|-------|
| 0820.240 | 240 mm | 1000 gr | ● | 69,00 |
| 0820.260 | 260 mm | 1200 gr | ● | 78,00 |



Cuchillo jamón
Mango inyectado

| Ref. | Largo | Color | Euros |
|----------|--------|-------|-------|
| 0526.250 | 250 mm | ● | 13,50 |
| 0526.300 | 300 mm | ● | 16,00 |



Cuchillo jamón
Hoja estrecha, mango polietileno

| Ref. | Largo | Color | Euros |
|----------|--------|-------|-------|
| 0540.250 | 250 mm | ● | 14,50 |
| 0540.305 | 305 mm | ● | 15,50 |



Cuchillo jamonero
Mango polietileno. Hoja recia.

| Ref. | Largo | Color | Euros |
|----------|--------|-------|-------|
| 0521.250 | 250 mm | ● | 19,00 |
| 0521.300 | 300 mm | ● | 21,00 |



Cuchillo jamonero
Mango polietileno. Hoja flexible

| Ref. | Largo | Color | Euros |
|----------|--------|-------|-------|
| 0500.305 | 305 mm | ● | 16,00 |



Cuchillo Jamonero Mango Pom Alveolado

| Ref. | Largo | Color | Euros |
|----------|--------|-------|-------|
| 4120.250 | 250 mm | ● | 27,00 |
| 4120.300 | 300 mm | ● | 33,00 |



Cuchillo jamonero
Mango phenolkraff

| Ref. | Largo | Color | Euros |
|----------|--------|-------|-------|
| 4020.300 | 300 mm | ●●●●● | 46,00 |



Cuchillo pescadero
Mango inyectado

| Ref. | Largo | Color | Euros |
|----------|--------|-------|-------|
| 0701.320 | 320 mm | ●●●●● | 50,00 |
| 0701.350 | 350 mm | ●●●●● | 55,00 |
| 0701.370 | 370 mm | ●●●●● | 60,00 |



Cortante bacalao
Mango polietileno

| Ref. | Largo | Color | Euros |
|----------|--------|-------|-------|
| 0775.190 | 190 mm | ● | 53,00 |



Cuchillo pescadero
L/vaca M/polietileno

| Ref. | Largo | Color | Euros |
|----------|--------|-------|-------|
| 0720.350 | 350 mm | ● | 66,00 |
| 0720.380 | 380 mm | ● | 71,00 |



Escamador pescado
profesional

| Ref. | Largo | Euros |
|----------|-------|-------|
| 2526.000 | 25 cm | 19,00 |



Cuchillo charcutero salmonero-jamonero
Alveolado estrecho, mango polietileno

| Ref. | Largo | Color | Euros |
|----------|--------|-------|-------|
| 0560.310 | 310 mm | ● | 26,00 |



Cuchillo chef Santoku mango pom

| Ref. | Largo | Color | Euros |
|----------|--------|-------|-------|
| 4105.180 | 180 mm | ● | 27,00 |



Cuchillo degollar
Mango inyectado

| Ref. | Largo | Color | Euros |
|----------|--------|-------|-------|
| 0370.165 | 165 mm | ● | 18,00 |
| 0370.195 | 195 mm | ● | 20,00 |
| 0370.225 | 225 mm | ● | 21,50 |

Cuchillo cocinero forjado
Mango phenolkruff

| Ref. | Largo | Color | Euros |
|----------|--------|-------|-------|
| 4000.100 | 100 mm | ●●●●● | 23,00 |
| 4000.150 | 150 mm | ●●●●● | 34,50 |
| 4000.200 | 200 mm | ●●●●● | 48,00 |
| 4000.250 | 250 mm | ●●●●● | 57,00 |
| 4000.300 | 300 mm | ●●●●● | 72,00 |



Cuchillo deshuesar
Mango phenoldraff

| Ref. | Largo | Color | Euros |
|----------|--------|-------|-------|
| 4010.150 | 150 mm | ●●●●● | 32,00 |

Trinchante cocinero
Mango phenolkruff

| Ref. | Largo | Color | Euros |
|----------|--------|-------|-------|
| 4050.180 | 180 mm | ●●●●● | 40,00 |



Cuchillo chef mango pom

| Ref. | Largo | Color | Euros |
|----------|--------|-------|-------|
| 4100.150 | 150 mm | ● | 15,50 |
| 4100.200 | 200 mm | ● | 21,00 |
| 4100.250 | 250 mm | ● | 28,50 |



Cuchillo chef mango pom alveolado

| Ref. | Largo | Color | Euros |
|----------|--------|-------|-------|
| 4101.250 | 250 mm | ● | 35,00 |



Cuchillo de Golpe Mango Rallado Polipropileno

| Ref. | Largo | Color | Euros |
|----------|-------------|-------|-------|
| 0600.300 | 85 x 300 mm | ● | 48,00 |
| 0600.350 | 95 x 300 mm | ● | 62,00 |



Cuchillo Punta Aguda Mango Inyectado Anatomico y Antideslizante

| Ref. | Largo | Color | Euros |
|----------|--------|-------|-------|
| 4200.150 | 150 mm | ●●●●● | 13,50 |
| 4200.200 | 200 mm | ●●●●● | 18,50 |
| 4200.250 | 250 mm | ●●●●● | 24,00 |
| 4200.280 | 280 mm | ●●●●● | 27,50 |



Cuchillo queso curvado

| Ref. | Largo | Color | Euros |
|----------|-------|-------|-------|
| 1000.450 | 45 cm | ● | 60,00 |



**Cuchillo queso
1 mango acodado con alveolos. Mango Phenolkruff**

| Ref. | Largo | Color | Euros |
|----------|--------|-------|-------|
| 1000.305 | 305 mm | ● | 52,00 |

**Cuchillo queso
2 mangos acodado. Mango polietileno**

| Ref. | Largo | Color | Euros |
|----------|--------|-------|-------|
| 1001.320 | 320 mm | ● | 54,00 |

**Cuchillo queso
2 mangos polietileno**

| Ref. | Largo | Color | Euros |
|----------|--------|-------|-------|
| 1001.260 | 260 mm | ● | 32,00 |
| 1001.290 | 290 mm | ● | 39,00 |



**Cuchillo queso
Sierra mango phenolkruff**

| Ref. | Largo | Color | Euros |
|----------|--------|-------|-------|
| 2002.250 | 250 mm | ● | 22,50 |
| 2002.310 | 310 mm | ● | 26,50 |



Cuchillo chef para pan mango pom

| Ref. | Largo | Color | Euros |
|----------|--------|-------|-------|
| 4102.230 | 230 mm | ● | 18,50 |



**Cuchillo charcutero-pastelero
Mango polietileno**

| Ref. | Largo | Color | Euros |
|----------|--------|-------|-------|
| 0575.250 | 250 mm | ● | 24,00 |
| 0575.300 | 300 mm | ● | 33,00 |
| 0575.360 | 360 mm | ● | 42,00 |



Cuchillo cocinero media luna

| Ref. | Largo | Color | Euros |
|----------|--------|-------|-------|
| 4300.270 | 270 mm | ● | 48,00 |



Cuchillo puntilla mango Penolkruff

| Ref. | Largo | Euros |
|----------|--------|-------|
| 0010.100 | 100 mm | 7,50 |



Cuchillo serie clásica puntilla curva mango pom

| Ref. | Largo | Color | Euros |
|----------|-------|-------|-------|
| 0015.065 | 65 mm | ● | 7,50 |



Gubia recta

| Ref. | Largo | Euros |
|----------|--------|-------|
| 2401.230 | 230 mm | 34,50 |



Gubia de bola m/polietileno blanco

| Ref. | Largo | Color | Euros |
|----------|--------|-------|-------|
| 2401.260 | 260 mm | ○ | 46,00 |



Aplasta filetes inox

| Ref. | Largo | Euros |
|----------|------------|-------|
| 1701.135 | 23 x 11 cm | 37,00 |



Aplasta filetes Acero inox.

| Ref. | Peso | Euros |
|----------|--------|-------|
| 1705.150 | 1,5 kg | 42,00 |



Afilador manual sobremesa

| Ref. | Euros |
|------|-------|
| F-40 | 22,00 |



Afilador manual diamante

| Ref. | Euros |
|------|--------|
| F-35 | 120,00 |



Juego varillas diamante para ref. F-35

| Ref. | Euros |
|------|-------|
| F-36 | 47,00 |

AFILADORAS ELÉCTRICAS DISPONIBLES EN LA FAMILIA 5

PIEDRAS AFILAR



Piedra de afilar natural. Grano negro. Rombo

| Ref. | Largo | Euros |
|----------|-------|-------|
| 3900.700 | 23 cm | 9,00 |

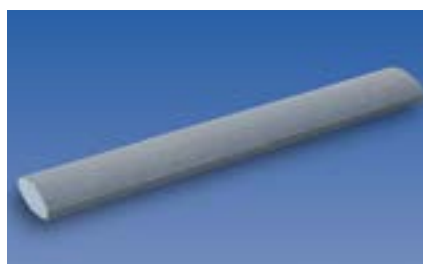

Piedra de afilar corindón. Grano grueso. Oval

| Ref. | Largo | Euros |
|----------|-------|-------|
| 3900.750 | 24 cm | 11,00 |

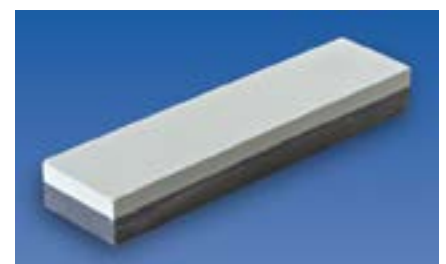

Piedra de afilar silicar, 1 cara grano fino y 1 cara grano grueso

| Ref. | Medidas | Euros |
|----------|---------------|-------|
| 3900.995 | 20 x 5 x 2 cm | 36,00 |



Piedra de afilar con mango

| Ref. | Medidas | Euros |
|----------|---------|-------|
| 3900.650 | 24 cm | 6,00 |



Chairas profesional redonda

| Ref. | Largo | Euros |
|----------|-------|-------|
| 3000.200 | 20 cm | 10,50 |
| 3000.250 | 25 cm | 21,00 |
| 3000.300 | 30 cm | 23,00 |

Profesional oval 30

| Ref. | Largo | Euros |
|----------|-------|-------|
| 3050.300 | 30 cm | 40,00 |



Profesional redonda cruzeta inox 30 cm

| Ref. | Largo | Euros |
|----------|-------|-------|
| 3100.300 | 30 cm | 46,00 |

Profesional oval cruzeta inox

| Ref. | Largo | Euros |
|----------|-------|-------|
| 3150.300 | 30 cm | 58,00 |



Profesional redonda

| Ref. | Largo | Color | Euros |
|-------------|-------|-------|-------|
| 3200.300-N | 30 cm | ● | 39,00 |
| 3200.300-AZ | 30 cm | ● | 39,00 |
| 3200.300-A | 30 cm | ● | 39,00 |
| 3200.300-R | 30 cm | ● | 39,00 |
| 3200.300-V | 30 cm | ● | 39,00 |



Oval profesional

| Ref. | Largo | Color | Euros |
|-------------|-------|-------|-------|
| 3250.300-N | 30 cm | ● | 56,00 |
| 3250.300-AZ | 30 cm | ● | 56,00 |
| 3250.300-A | 30 cm | ● | 56,00 |
| 3250.300-R | 30 cm | ● | 56,00 |
| 3250.300-V | 30 cm | ● | 56,00 |



Profesional oval acero inoxidable

| Ref. | Largo | Color | Euros |
|----------|-------|-------|--------|
| 3400.300 | 30 cm | ● | 115,00 |



Lujo extra plana

| Ref. | Largo | Color | Euros |
|----------|-------|-------|--------|
| 3500.300 | 30 cm | ● | 106,00 |



Tijera pollero

| Ref. | Largo | Euros |
|--------|-------|-------|
| TP-210 | 21 cm | 51,50 |
| TP-230 | 23 cm | 60,00 |
| TP-250 | 25 cm | 63,50 |



Tijera forjada

| Ref. | Largo | Euros |
|--------|-------|-------|
| TC-180 | 18 cm | 17,00 |
| TC-200 | 20 cm | 19,00 |
| TC-220 | 22 cm | 23,00 |
| TC-240 | 24 cm | 40,00 |
| TC-280 | 28 cm | 49,50 |



Tijera forjada

| Ref. | Largo | Euros |
|--------|---------|-------|
| TF-200 | 20 cm | 28,00 |
| TF-225 | 22,5 cm | 30,00 |



Tijera trinchar

| Ref. | Largo | Euros |
|--------|---------|-------|
| TT-265 | 26,5 cm | 29,00 |



Tijera mostrador con soporte inox Mango polietileno

| Ref. | Largo | Euros |
|--------|-------|--------|
| TM-430 | 43 cm | 220,00 |
| TM-500 | 50 cm | 245,00 |

BACALADERA



Bacaladera manual Base polietileno

| Ref. | Euros |
|------|--------|
| A-25 | 135,00 |



Hacha de cámara
Mango polietileno

| Ref. | Euros |
|------|--------|
| A-6 | 153,00 |



Hacha de corte, 1kg
Mango polietileno

| Ref. | Euros |
|------|--------|
| A-16 | 120,00 |

VARIOS



Pincha salchichas 6 pinchos
Mango plástico, acero inox

| Ref. | Euros |
|------|-------|
| F-12 | 11,00 |



Pincha salchichas redondo 16 pinchos inox

| Ref. | Euros |
|------|-------|
| F-17 | 8,00 |



Aguja de mechar

| Ref. | Largo | Euros |
|------|-------|-------|
| F-13 | 30 cm | 41,00 |



Aguja para hilo

| Ref. | Largo | Euros |
|------|-------|-------|
| F-14 | 30 cm | 28,00 |

Espátula plancha

| Ref. | Medidas | Euros |
|------|---------|-------|
| A-21 | 9 cm | 14,50 |

Espátula pastelero

| Ref. | Largo | Euros |
|------|-------|-------|
| A-51 | 20 cm | 15,00 |
| A-52 | 25 cm | 21,00 |

Paleta charcutería

| Ref. | Medidas | Euros |
|------|-----------|-------|
| A-14 | 12 x 6 cm | 14,50 |

Paleta acodada

| Ref. | Medidas | Euros |
|------|-----------|-------|
| A-22 | 15 x 8 cm | 19,00 |

Paleta besugo ancha

| Ref. | Medidas | Euros |
|------|------------|-------|
| A-53 | 16 x 19 cm | 30,00 |

Paleta besugo larga

| Ref. | Medidas | Euros |
|------|-----------|-------|
| A-54 | 25 x 8 cm | 27,00 |

9 ACCESORIOS ACERO INOXIDABLE



Abre-ostras industrial

| Ref. | Euros |
|------|--------|
| A-56 | 137,00 |



Abre-ostras acero-inox con protector

| Ref. | Euros |
|------|-------|
| A-2 | 8,00 |



Rasqueta multiservicio

| Ref. | Medidas | Euros |
|------|------------|-------|
| A-18 | 15 x 12 cm | 14,00 |

SIERRAS



**Sierra huesos
Inox, Mango negro**

| Ref. | Largo | Euros |
|----------|-------|-------|
| 2460.400 | 40 cm | 60,00 |
| 2460.450 | 45 cm | 62,00 |
| 2460.500 | 50 cm | 66,00 |

Hoja recambio sierra inox

| Ref. | Largo | Euros |
|----------|-------|-------|
| 2476.420 | 40 cm | 9,00 |
| 2476.450 | 45 cm | 10,00 |
| 2476.500 | 50 cm | 11,50 |

IMANES

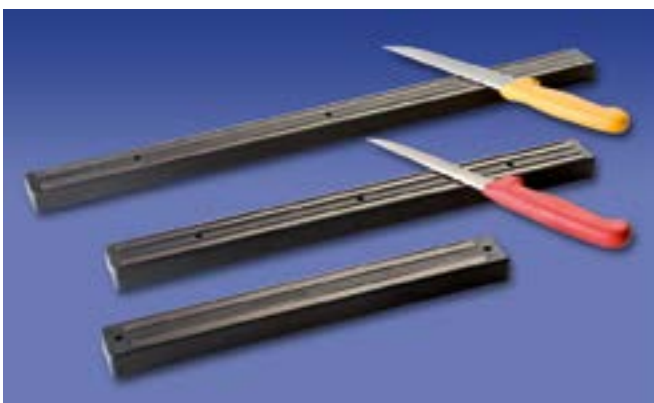

Imanes

| Ref. | Largo | Euros |
|----------|-------|-------|
| 2500.330 | 33 cm | 17,00 |
| 2500.450 | 45 cm | 21,00 |
| 2500.600 | 60 cm | 25,00 |



Guillotina queso blando
Base polietileno

| Ref. | Euros |
|------|--------|
| F-20 | 165,00 |

Recambio guillotina ref. F-20
Pack 10 unidades

| Ref. | Unidades | Euros |
|------|----------|-------|
| F-21 | 10 | 11,50 |



Lira queso blando de 21 cm

| Ref. | Euros |
|------|-------|
| F-15 | 16,00 |

Recambio lira Ref. F-15
Pack 10 unidades

| Ref. | Unidades | Euros |
|------|----------|-------|
| F-16 | 10 | 10,00 |



Rizador queso
Base madera 22 cm diametro

| Ref. | Euros |
|------|-------|
| F-22 | 31,00 |

ABRELATAS Y SACACORCHOS



Abrelatas industrial inox

| Ref. | Euros |
|------|--------|
| A-70 | 140,00 |



Guantes 5 dedos inox banda plástico reversibles

| Ref. | Color | Tipo | Euros |
|----------|-------|------|-------|
| A-1050-X | ● | XXS | 96,00 |
| A-1051-X | ● | XS | 96,00 |
| A-1052-X | ○ | S | 96,00 |
| A-1053-X | ● | M | 96,00 |
| A-1054-X | ● | L | 96,00 |
| A-1055-X | ● | XL | 96,00 |



Guantes 5 dedos inox banda plástico con manguito inox 19 cm reversible

| Ref. | Color | Tipo | Euros |
|--------|-------|------|--------|
| A-1150 | ● | XXS | 180,00 |
| A-1151 | ● | XS | 180,00 |
| A-1152 | ○ | S | 180,00 |
| A-1153 | ● | M | 180,00 |
| A-1154 | ● | L | 180,00 |
| A-1155 | ● | XL | 180,00 |



Guantes 5 dedos inox banda nylon con manguito policarbonato CHAINEX

| Ref. | Color | Tipo | Euros |
|--------|-------|------|--------|
| A-1020 | ● | XXS | 195,00 |
| A-1021 | ● | XS | 195,00 |
| A-1022 | ○ | S | 195,00 |
| A-1023 | ● | M | 195,00 |
| A-1024 | ● | L | 195,00 |



Guantes 5 dedos inox banda nylon con manguito inox 16.5 cm reversible CHAINEX

| Ref. | Color | Tipo | Euros |
|--------|-------|------|--------|
| A-1110 | ● | XXS | 185,00 |
| A-1111 | ● | XS | 185,00 |
| A-1112 | ○ | S | 185,00 |
| A-1113 | ● | M | 185,00 |
| A-1114 | ● | L | 185,00 |
| A-1115 | ● | XL | 185,00 |



Sujeción de plástico para guantes inox

| Ref. | Unidades | Euros |
|--------|----------|-------|
| A-1000 | 100 | 35,00 |



Guantes anticorte alimentario.
Galga 13
Puño elástico
Ambidiestro.
Precio por pareja

| Ref. | Tipo | Euros |
|--------|-------|-------|
| A-2001 | S 7 | 18,00 |
| A-2002 | M 8 | 18,00 |
| A-2003 | L 9 | 18,00 |
| A-2004 | XL 10 | 18,00 |



Guantes anticolor con malla metálica.
Hasta 500° C de contacto.
Forro aislante.
Serraje vacuno marrón.
Longitud total 40 cm
Talla única.
Precio por pareja

| Ref. | Euros |
|--------|--------|
| A-8533 | 165,00 |



Manopla anticolor con malla metálica
Hasta 500° C de contacto.
Forro aislante.
Serraje vacuno marrón.
Longitud total 40 cm
Talla única.
Precio por pareja

| Ref. | Euros |
|--------|--------|
| A-8633 | 139,00 |



Guantes textil anticolor.
Hasta 350° C de contacto.
Puño elástico y forro de algodón.
Galga 7.
Talla única.
Precio por pareja.
Opción corto/largo (36 cm)

| Ref. | Euros |
|--------|-------|
| A-5548 | 39,00 |



Manopla silicona 300°

| Ref. | Euros |
|--------|-------|
| A-3000 | 35,00 |



Manopla silicona 300° extra larga

| Ref. | Euros |
|--------|-------|
| A-3005 | 49,00 |



Manopla silicona azul (27 cm)
 Hasta 250° C de contacto
 Impermeable
 Acabado antideslizante en palma
 Orificio para colgar
 Precio por unidad

| Ref. | Euros |
|-----------|-------|
| A-3000-AZ | 24,00 |



Manopla silicona azul (44 cm)
 Hasta 250° C de contacto
 Impermeable
 Acabado antideslizante en palma
 Orificio para colgar
 Precio por unidad

| Ref. | Euros |
|-----------|-------|
| A-3005-AZ | 32,00 |



Guantes para manipulación de alimentos congelados o refrigerados.
 Soporte poliéster azul y elastómero.
 Recubrimiento completo de látex azul.
 Recubrimiento negro látex Sandy grip en palma.
 Interior acrílico rizado negro.
 Puño elástico
 Galga 10
 Precio por pareja

| Ref. | Euros |
|----------|-------|
| A-760-8 | 12,00 |
| A-760-9 | 12,00 |
| A-760-10 | 12,00 |
| A-760-11 | 12,00 |



Delantal malla acero
Medidas 75 x 55

| Ref. | Medidas | Euros |
|---------|------------|--------|
| A-9-76M | 75 x 55 cm | 185,00 |

DELANTALES



Delantal PVC

| Ref. | Medidas | Color | Euros |
|-------------|-------------|-------|-------|
| A-11-120-AZ | 70 x 120 cm | ● | 22,00 |
| A-11-110-AZ | 70 x 110 cm | ● | 22,00 |
| A-11-90 | 70 x 90 cm | ○ | 22,00 |
| A-11-90-AZ | 70 x 90 cm | ● | 19,00 |
| A-11-90-N | 70 x 90 cm | ● | 19,00 |
| A-11-90-R | 70 x 90 cm | ● | 19,00 |



Delantal TPU ligero

| Ref. | Medidas | Color | Euros |
|----------|----------|-------|-------|
| A-11-110 | 87 x 115 | ○ | 49,00 |



Delantal textil

| Ref. | Medidas | Euros |
|---------|------------|-------|
| A-17-B | 75 x 90 cm | 14,50 |
| A-17-P | 75 x 90 cm | 14,50 |
| A-17-BU | 75 x 90 cm | 14,50 |
| A-17-F | 75 x 90 cm | 14,50 |
| A-17-N | 75 x 90 cm | 14,50 |



Delantal textil rayado

| Ref. | Medidas | Euros |
|----------|------------|-------|
| A-17-NV | 75 x 90 cm | 18,00 |
| A-17-NBU | 75 x 90 cm | 18,00 |
| A-17-BR | 75 x 90 cm | 18,00 |
| A-17-BAZ | 75 x 90 cm | 18,00 |
| A-17-BV | 75 x 90 cm | 18,00 |

GUANTES LATEX Y VINILO DE UN SOLO USO



Guantes plástico "un solo uso", paquete 100 und.

| Ref. | Unidades | Euros |
|------|----------|-------|
| A-12 | 100 | 0,80 |



10

Estanterías

Plataformas

Tarimas antifatiga

Palets

Losetas

Bancos de vestuario

Taquillas

177 - 192



HIGIÉNICAS

- Superficie lisa, ligera y no porosa.
- Fabricadas con resina de alta calidad.
- Evitan la condensación.
- Recomendado para ambientes húmedos.
- No se oxidan.
- Cantos redondeados, para evitar accidentes.
- Colores: blanco, gris y beige.

RESISTENTES

- Resistencia a la carga 400 kg/m2 por estante.
- Soporta temperaturas desde -40°C a 80°C.
- Inalterables a ácidos, aceites, grasas y humedades.
- No se manchan con el uso de detergentes.

VERSÁTILES

- Se amplian fácilmente con nuevos elementos.
- Se amoldan sin dificultad a diferentes alturas.
- Módulos especialmente diseñados para un máximo aprovechamiento de las esquinas.
- Pies regulables (opcionales), para suelos irregulares o inclinados.
- Ruedas (opcionales).

MODULARES

- Se acoplan a cualquier distribución de espacio.
- Sobre pedido se construyen en cualquier medida.

ADAPTABLES

- Módulos diseñados para adaptarse a cualquier necesidad.
- Se montan con mucha facilidad sin precisar elementos metálicos.
- Su ligereza permite desplazarlas fácilmente.
- Empaquetadas premontadas para facilitar su montaje.

Desmontadas para transporte
Fácil manejo

OPCIONES A ELEGIR



Placas de polietileno a medida para los estantes.



Ruedas de poliamida.**



Patas regulables.*



Ruedas cincadas.***

| Ref. | Euros | Ref. | Euros | Ref. | Euros |
|-------|-------|----------|--------|---------|-------|
| *K-10 | 8,50 | **K-15-P | 113,00 | ***K-15 | 91,00 |

COLORES A ELEGIR PARA LAS ESTANTERIAS



Estanterías modulares estándar 4 estantes cantos rectos

| Ref. | Medidas | Euros |
|-------|-------------------|--------|
| K-104 | 100 x 40 x 150 cm | 474,00 |
| K-105 | 100 x 50 x 150 cm | 527,00 |
| K-106 | 100 x 60 x 150 cm | 585,00 |
| K-124 | 120 x 40 x 150 cm | 516,00 |
| K-125 | 120 x 50 x 150 cm | 574,00 |
| K-126 | 120 x 60 x 150 cm | 644,00 |
| K-154 | 150 x 40 x 150 cm | 641,00 |
| K-155 | 150 x 50 x 150 cm | 717,00 |
| K-156 | 150 x 60 x 150 cm | 805,00 |
| K-204 | 200 x 40 x 150 cm | 734,00 |
| K-205 | 200 x 50 x 150 cm | 828,00 |
| K-206 | 200 x 60 x 150 cm | 918,00 |

Estantería modulares estándar 5 estantes cantos rectos

| Ref. | Medidas | Euros |
|---------|-------------------|---------|
| K-104-5 | 100 x 40 x 175 cm | 593,00 |
| K-105-5 | 100 x 50 x 175 cm | 658,00 |
| K-106-5 | 100 x 60 x 175 cm | 730,00 |
| K-124-5 | 120 x 40 x 175 cm | 644,00 |
| K-125-5 | 120 x 50 x 175 cm | 718,00 |
| K-126-5 | 120 x 60 x 175 cm | 805,00 |
| K-154-5 | 150 x 40 x 175 cm | 802,00 |
| K-155-5 | 150 x 50 x 175 cm | 909,00 |
| K-156-6 | 150 x 60 x 175 cm | 1007,00 |
| K-204-5 | 200 x 40 x 150 cm | 918,00 |
| K-205-5 | 200 x 50 x 175 cm | 1035,00 |
| K-206-5 | 200 x 60 x 175 cm | 1147,00 |



ESTANTERÍAS RESISTENTES, HIGIÉNICAS, PLEGABLES Y VERSÁTILES

- Resistencia a la carga 250 kg/m².
- Inalterable a la humedad, ácidos, aceites y grasas.
- No se mancha con el uso de detergentes.

HIGIÉNICAS

- Superficie no porosa.
- Fabricadas con resinas de alta calidad.
- Evitan la condensación.
- Recomendado para ambientes húmedos.
- No se oxidan.
- Cantos romos para evitar accidentes.
- Baldas extraíbles para su lavado industrial.

VERSÁTILES

- Ampliables con nuevos elementos (modulares).
- Fácilmente amoldables a nuevas alturas.
- Módulos especialmente diseñados para un mejor aprovechamiento de las esquinas.
- Accesorios para diferentes utilidades.
- Plegables para el mejor aprovechamiento de espacios.
- Baldas caladas o llenas.
- Empaquetadas premontadas para facilitar su montaje.



Baldas extraíbles para facilitar su lavado, pueden lavarse en el lavavajillas



El sistema de plegado permite optimizar el volumen de empaquetado y transporte



Sistema de encaje

OPCIONES A ELEGIR



Baldas lisas solo para gamas 400 y 500.



Baldas caladas para todas las gamas.



Patas regulables

COLORES A ELEGIR PARA LAS ESTANTERIAS



*La gama marca la profundidad de la estanteria (400 = 40 cm / 500 = 50 cm / 600 = 60 cm)

Estanterías plegables modulares 4 estantes

| Ref. | Medidas | Euros |
|--------|-------------------|--------|
| KM-104 | 100 x 40 x 150 cm | 487,00 |
| KM-105 | 100 x 50 x 150 cm | 527,00 |
| KM-106 | 100 x 60 x 150 cm | 556,00 |
| KM-124 | 120 x 40 x 150 cm | 574,00 |
| KM-125 | 120 x 50 x 150 cm | 630,00 |
| KM-126 | 120 x 60 x 150 cm | 680,00 |
| KM-154 | 150 x 40 x 150 cm | 690,00 |
| KM-155 | 150 x 50 x 150 cm | 742,00 |
| KM-156 | 150 x 60 x 150 cm | 794,00 |
| KM-204 | 200 x 40 x 150 cm | 812,00 |
| KM-205 | 200 x 50 x 150 cm | 870,00 |
| KM-206 | 200 x 60 x 150 cm | 955,00 |

Estanterías plegables modulares 5 estantes

| Ref. | Medidas | Euros |
|----------|-------------------|---------|
| KM-104-5 | 100 x 40 x 175 cm | 610,00 |
| KM-105-5 | 100 x 50 x 175 cm | 669,00 |
| KM-106-5 | 100 x 60 x 175 cm | 694,00 |
| KM-124-S | 120 x 40 x 175 cm | 718,00 |
| KM-125-5 | 120 x 50 x 175 cm | 786,00 |
| KM-126-5 | 120 x 60 x 175 cm | 849,00 |
| KM-154-5 | 150 x 40 x 175 cm | 863,00 |
| KM-155-5 | 150 x 50 x 175 cm | 927,00 |
| KM-156-5 | 150 x 60 x 175 cm | 992,00 |
| KM-204-5 | 200 x 40 x 175 cm | 1016,00 |
| KM-205-5 | 200 x 50 x 175 cm | 1087,00 |
| KM-206-5 | 200 x 60 x 175 cm | 1194,00 |



HIGIÉNICAS

- Superficie lisa, ligera y no porosa.
- Fabricadas con resina de alta calidad.
- Evitan la condensación.
- Recomendado para ambientes húmedos.
- No se oxidan.
- Cantos redondeados, para evitar accidentes.
- Colores: blanco, gris y beige.

RESISTENTES

- Resistencia a la carga 250 kg/m2 por estante.
- Soporta temperaturas desde -40°C a 80°C.
- Inalterables a ácidos, aceites, grasas y humedades.
- No se manchan con el uso de detergentes.

VERSÁTILES

- Se amplian fácilmente con nuevos elementos.
- Se amoldan sin dificultad a diferentes alturas.
- Módulos especialmente diseñados para un máximo aprovechamiento de las esquinas.
- Pies regulables (opcionales), para suelos irregulares o inclinados.
- Ruedas (opcionales).

MODULARES

- Se acoplan a cualquier distribución de espacio.
- Sobre pedido se construyen en cualquier medida.

ADAPTABLES

- Módulos diseñados para adaptarse a cualquier necesidad.
- Se montan con mucha facilidad sin precisar elementos metálicos.
- Su ligereza permite desplazarlas fácilmente.
- Empaquetadas premontadas para facilitar su montaje.

CONSULTAR PRECIOS

OPCIONES A ELEGIR

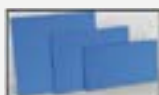

Baldas lisas solo para gamas 400 y 500.



Baldas caladas para todas las gamas.



Patas regulables



Ruedas poliamida



Ruedas cincadas

COLORES A ELEGIR PARA LAS ESTANTERIAS

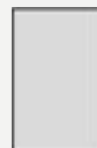

*La gama marca la profundidad de la estantería (400 = 40 cm / 500 = 50 cm / 600 = 60 cm)

VARIANTES A ELEGIR PARA TODAS LAS ESTANTERÍAS

VACÍO

Todas las estanterías, de gama 400, 500, 600 y de 4 o 5 niveles, las fabricamos también sin el estante inferior. Por lo tanto, tendremos estantería de 3 niveles + VACÍO, y de 4 niveles + VACÍO.



ESQUINERAS

También fabricamos estanterías esquineras. Medidas estándares o especiales. Esquineras de un lado o de ambos lados. Mayor aprovechamiento de las esquinas.

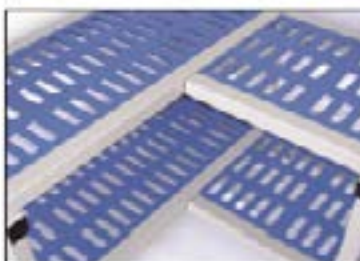

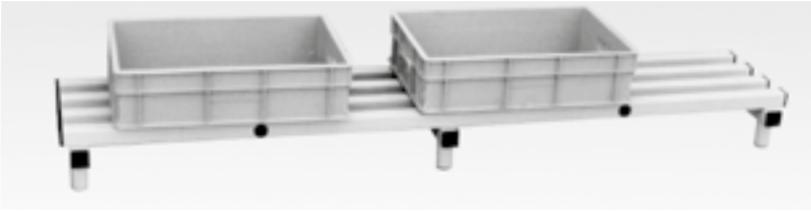

- Plataformas y tarimas muy resistentes a las cargas y a la vez ligeras, permitiendo su fácil desplazamiento.
- Soportan temperaturas desde -40°C a 80°C.
- Recomendado para ambientes húmedos.
- Tarimas antifatiga, termoaislantes con suelo antideslizante para proteger de resbalones al trabajador.
- Evitan posibles descargas eléctricas.
- Ampliables con nuevos elementos y amoldables a nuevas alturas.
- Empaquetadas totalmente montadas.
- Colores a elegir: blanco, gris y beige.

Plataformas para suelo

| Ref. | Medidas | Euros | Ref. | Medidas | Euros |
|--------|--------------------|--------|--------|--------------------|--------|
| KP-104 | 100 x 40 x 16,5 cm | 110,00 | KP-154 | 150 x 40 x 16,5 cm | 141,00 |
| KP-105 | 100 x 50 x 16,5 cm | 121,00 | KP-155 | 150 x 50 x 16,5 cm | 164,00 |
| KP-106 | 100 x 60 x 16,5 cm | 137,00 | KP-156 | 150 x 60 x 16,5 cm | 181,00 |
| KP-124 | 120 x 40 x 16,5 cm | 125,00 | KP-204 | 200 x 40 x 16,5 cm | 166,00 |
| KP-125 | 120 x 50 x 16,5 cm | 143,00 | KP-205 | 200 x 50 x 16,5 cm | 188,00 |
| KP-126 | 120 x 60 x 16,5 cm | 158,00 | KP-206 | 200 x 60 x 16,5 cm | 210,00 |

TARIMAS ANTIFATIGA



Tarimas antifatiga

| Ref. | Medidas | Euros |
|---------|------------------|--------|
| KTA-105 | 100 x 50 x 18 cm | 443,00 |
| KTA-106 | 100 x 60 x 18 cm | 532,00 |
| KTA-107 | 100 x 70 x 18 cm | 620,00 |
| KTA-108 | 100 x 80 x 18 cm | 709,00 |



Palet perforado reciclado negro.
Carga dinámica hasta 850 kg.
Carga estática hasta 3.400 kg.
Superficie apoyo 9 patas.

| Ref. | Medidas | Peso | Euros |
|--------|--------------------|--------|-------|
| KP-250 | 120 x 80 x 14,5 cm | 6,5 kg | 29,00 |

Palet liso reciclado negro.
Carga dinámica hasta 850 kg.
Carga estática hasta 3.400 kg.
Superficie apoyo 9 patas.

| Ref. | Medidas | Peso | Euros |
|--------|--------------------|--------|-------|
| KP-300 | 120 x 80 x 14,5 cm | 7,5 kg | 57,00 |

Palet liso alimentario blanco.
Carga dinámica hasta 850 kg.
Carga estática hasta 3.400 kg.
Superficie apoyo 9 patas.

| Ref. | Medidas | Peso | Euros |
|--------|--------------------|--------|-------|
| KP-350 | 120 x 80 x 14,5 cm | 7,5 kg | 77,00 |



Palet plástico reciclado negro.
Carga dinámica hasta 1.000 kg.
Carga estática hasta 4.000 kg.

| Ref. | Medidas | Peso | Euros |
|--------|------------------|-------|-------|
| KP-400 | 120 x 80 x 16 cm | 21 kg | 95,00 |



Palet plástico gris alimentario.
Carga dinámica hasta 1.000 kg.
Carga estática hasta 4.000 kg.

| Ref. | Medidas | Peso | Euros |
|--------|------------------|------|-------|
| KP-500 | 120 x 80 x 16 cm | 18 | 90,00 |





Loseta suelo

| Ref. | Medidas | Color | Euros |
|-------|------------------|-------|-------|
| KL-25 | 50 x 50 x 2,5 cm | ● ○ ● | 16,00 |

Otros colores consultar.

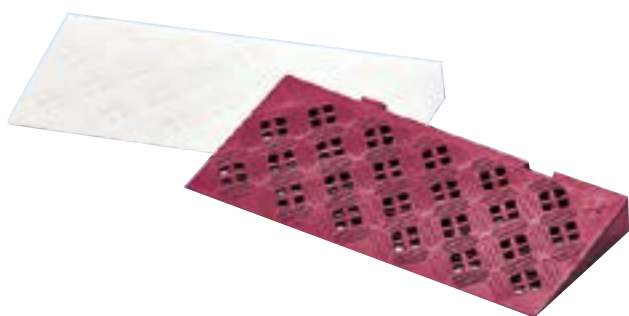

Rampa para ref. KL-100 y KL-55

| Ref. | Medidas | Color | Euros |
|-------|------------|-------|-------|
| KL-50 | 50 x 20 cm | ● ○ ● | 24,00 |



Loseta suelo

| Ref. | Medidas | Color | Euros |
|-------|----------------|-------|-------|
| KL-55 | 50 x 50 x 5 cm | ● ○ ● | 25,00 |

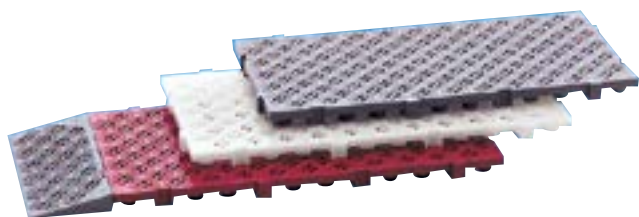

Loseta suelo

| Ref. | Medidas | Color | Euros |
|--------|-----------------|-------|-------|
| KL-100 | 100 x 50 x 5 cm | ● ○ ● | 52,00 |



BANCOS DE VESTUARIO CANTOS RECTOS

- Resistencia a la carga de 400 kg/m².
- Soporta temperatura de -40°C a 80°C.
- Resistentes, higiénicos y ligeros.
- Recomendado para ambientes húmedos.
- Empaquetados premontados para facilitar el montaje.

Banco vestuario

| Ref. | Medidas | Euros |
|----------------|--------------------|---------------|
| KBV-100 | 100 x 35 x 48,5 cm | 272,00 |
| KBV-150 | 150 x 35 x 48,5 cm | 350,00 |
| KBV-200 | 200 x 35 x 48,5 cm | 408,00 |

COLORES A ELEGIR PARA LOS BANCOS





10 TAQUILLAS

SON VERSÁTILES RESISTENTES
Y MUY COMPETITIVAS /

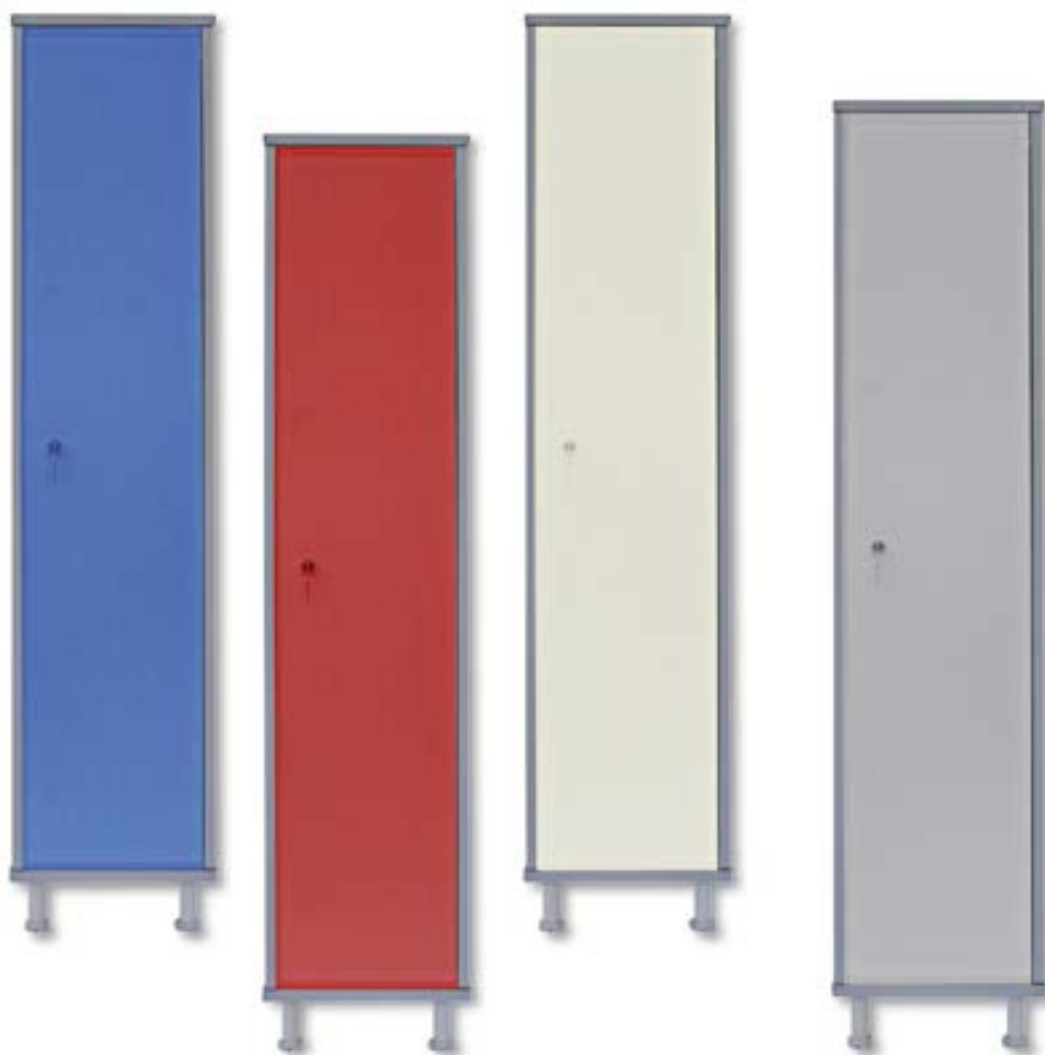

Personalización



Patas regulables



Cerradura de moneda

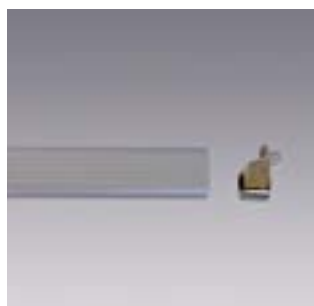

1/2 estante y barra de colgar



Cerradura estándar

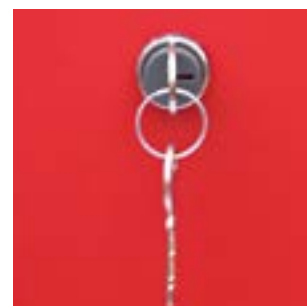

Cerradura estándar



Cierre por resbalón



Puerta pivotante

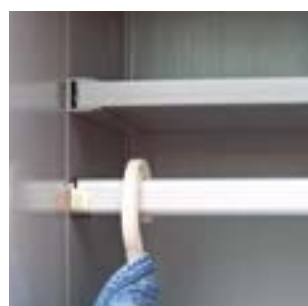

1/2 estante y barra de colgar



Pulsera numerada

GAMA 300
Cerradura de tipo pitones con 3.120 n° de combinaciones.
Cierre central y posibilidad de amaestramiento.
Color carcás en gris.
Color de la puerta en azul, rojo, beige o gris claro.

Material resinas de polivinilo.
Patás regulables de 13 a 18 cms.
Clasificación M1 según norma UNE 23727.

GAMA 300
 Cerradura de tipo pitones con 3.120 n° de combinaciones.
 Cierre central y posibilidad de amaestramiento.
 Color carcás en gris.
 Color de la puerta en azul, rojo, beige o gris claro.

Material resinas de polivinilo.
 Patás regulables de 13 a 18 cms.
 Clasificación M1 según norma UNE 23727.

GAMA 300
 Cerradura de tipo pitones con 3.120 n° de combinaciones.
 Cierre central y posibilidad de amaestramiento.
 Color carcás en gris.
 Color de la puerta en azul, rojo, beige o gris claro.

Material resinas de polivinilo.
 Patás regulables de 13 a 18 cms.
 Clasificación M1 según norma UNE 23727.

| | Módulo | Puerta | N° de Puertas | Medidas exterior total | Hueco útil por taquilla | Ref. | Euros | Accesorios incluidos |
|--|--------|--------|---------------|-------------------------|-------------------------|--------|---------|----------------------|
| | M1 | P1 | 1 | 29,4 x 53,7 x 191,5 cm | 24,6 x 48,9 x 174 cm | K3M1P1 | 410,00 | |
| | M2 | P1 | 2 | 55,7 x 53,7 x 191,5 cm | 24,6 x 48,9 x 174 cm | K3M2P1 | 739,00 | |
| | M3 | P1 | 3 | 82,2 x 53,7 x 191,5 cm | 24,6 x 48,9 x 174 cm | K3M3P1 | 1068,00 | |
| | M4 | P1 | 4 | 108,7 x 53,7 x 191,5 cm | 24,6 x 48,9 x 174 cm | K3M4P1 | 1397,00 | 1/2 Estante y barra |
| | M5 | P1 | 5 | 135,2 x 53,7 x 191,5 cm | 24,6 x 48,9 x 174 cm | K3M5P1 | 1725,00 | |
| | M6 | P1 | 6 | 161,7 x 53,7 x 191,5 cm | 24,6 x 48,9 x 174 cm | K3M6P1 | 2054,00 | |
| | M1 | P2 | 2 | 29,4 x 53,7 x 191,5 cm | 24,6 x 48,9 x 85,9 cm | K3M1P2 | 492,00 | |
| | M2 | P2 | 4 | 55,7 x 53,7 x 191,5 cm | 24,6 x 48,9 x 85,9 cm | K3M2P2 | 909,00 | |
| | M3 | P2 | 6 | 82,2 x 53,7 x 191,5 cm | 24,6 x 48,9 x 85,9 cm | K3M3P2 | 1326,00 | |
| | M4 | P2 | 8 | 108,7 x 53,7 x 191,5 cm | 24,6 x 48,9 x 85,9 cm | K3M4P2 | 1744,00 | Barra de colgar |
| | M5 | P2 | 10 | 135,2 x 53,7 x 191,5 cm | 24,6 x 48,9 x 85,9 cm | K3M5P2 | 2161,00 | |
| | M6 | P2 | 12 | 161,7 x 53,7 x 191,5 cm | 24,6 x 48,9 x 85,9 cm | K3M6P2 | 2579,00 | |
| | M1 | P3 | 3 | 29,4 x 53,7 x 191,5 cm | 24,6 x 48,9 x 56,5 cm | K3M1P3 | 571,00 | |
| | M2 | P3 | 6 | 55,7 x 53,7 x 191,5 cm | 24,6 x 48,9 x 56,5 cm | K3M2P3 | 1055,00 | |
| | M3 | P3 | 9 | 82,2 x 53,7 x 191,5 cm | 24,6 x 48,9 x 56,5 cm | K3M3P3 | 1606,00 | |
| | M4 | P3 | 12 | 108,7 x 53,7 x 191,5 cm | 24,6 x 48,9 x 56,5 cm | K3M4P3 | 2070,00 | |
| | M5 | P3 | 15 | 135,2 x 53,7 x 191,5 cm | 24,6 x 48,9 x 56,5 cm | K3M5P3 | 2566,00 | |
| | M6 | P3 | 18 | 161,7 x 53,7 x 191,5 cm | 24,6 x 48,9 x 56,5 cm | K3M6P3 | 3063,00 | |
| | M1 | P4 | 4 | 29,4 x 53,7 x 191,5 cm | 24,6 x 48,9 x 41,8 cm | K3M1P4 | 659,00 | |
| | M2 | P4 | 8 | 55,7 x 53,7 x 191,5 cm | 24,6 x 48,9 x 41,8 cm | K3M2P4 | 1224,00 | |
| | M3 | P4 | 12 | 82,2 x 53,7 x 191,5 cm | 24,6 x 48,9 x 41,8 cm | K3M3P4 | 1870,00 | |
| | M4 | P4 | 16 | 108,7 x 53,7 x 191,5 cm | 24,6 x 48,9 x 41,8 cm | K3M4P4 | 2448,00 | |
| | M5 | P4 | 20 | 135,2 x 53,7 x 191,5 cm | 24,6 x 48,9 x 41,8 cm | K3M5P4 | 3036,00 | |
| | M6 | P4 | 24 | 161,7 x 53,7 x 191,5 cm | 24,6 x 48,9 x 41,8 cm | K3M6P4 | 3624,00 | |
| | M1 | P5 | 5 | 29,4 x 53,7 x 191,5 cm | 24,6 x 48,9 x 33 cm | K3M1P5 | 748,00 | |
| | M2 | P5 | 10 | 55,7 x 53,7 x 191,5 cm | 24,6 x 48,9 x 33 cm | K3M2P5 | 1397,00 | |
| | M3 | P5 | 15 | 82,2 x 53,7 x 191,5 cm | 24,6 x 48,9 x 33 cm | K3M3P5 | 2151,00 | |
| | M4 | P5 | 20 | 108,7 x 53,7 x 191,5 cm | 24,6 x 48,9 x 33 cm | K3M4P5 | 2835,00 | |
| | M5 | P5 | 25 | 135,2 x 53,7 x 191,5 cm | 24,6 x 48,9 x 33 cm | K3M5P5 | 3519,00 | |
| | M6 | P5 | 30 | 161,7 x 53,7 x 191,5 cm | 24,6 x 48,9 x 33 cm | K3M6P5 | 4204,00 | |

NOTA: Las taquillas se suministran desmontadas, techo, suelo, laterales y fondo. El ensamblaje se realiza, encajando los dos laterales al fondo y uniendo mediante 12 tornillos el techo, el suelo y la puerta (tiempo 5 min.).

10 TAQUILLAS

| Accesorios | Precio PVP |
|------------------------------------|------------------|
| 1/2 Estante | 26,00 |
| 1 Estante | 37,00 |
| Barra de colgar | 16,50 |
| Patas regulables | <i>incluidas</i> |
| Zócalo 1 módulo lateral | 41,60 |
| Zócalo módulo central | 13,50 |
| Muñequera llave numerada | 15,00 |
| Numeración placa de 30 x15 | 8,00 |
| Techo inclinado 1 módulo laterales | 86,00 |
| Techo inclinado 1 módulo central | 43,00 |
| Cerradura de seguridad | CONSULTAR |
| Cerradura de monedas | 37,00 |

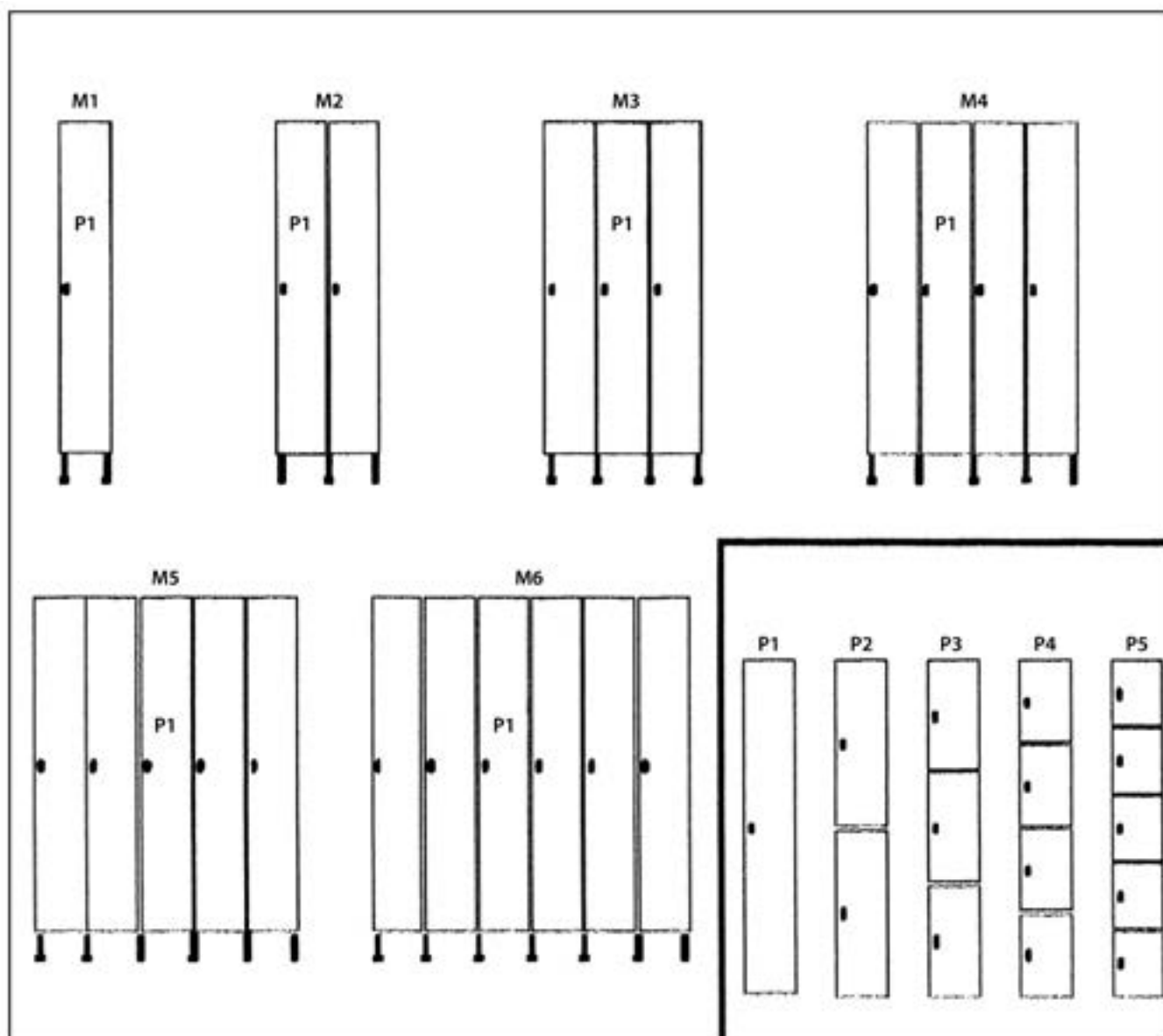

GAMA 400
Cerradura de tipo pitones con 3.120 nº de combinaciones.
Cierre central y posibilidad de amaestramiento.
Color carcás en gris.
Color de la puerta en azul, rojo, beige o gris claro.

Material resinas de polivinilo.
Patás regulables de 13 a 18 cms.
Clasificación M1 según norma UNE 23727.

GAMA 400
 Cerradura de tipo pitones con 3.120 nº de combinaciones.
 Cierre central y posibilidad de amaestramiento.
 Color carcás en gris.
 Color de la puerta en azul, rojo, beige o gris claro.

Material resinas de polivinilo.
 Patás regulables de 13 a 18 cms.
 Clasificación M1 según norma UNE 23727.

GAMA 400
 Cerradura de tipo pitones con 3.120 nº de combinaciones.
 Cierre central y posibilidad de amaestramiento.
 Color carcás en gris.
 Color de la puerta en azul, rojo, beige o gris claro.

Material resinas de polivinilo.
 Patás regulables de 13 a 18 cms.
 Clasificación M1 según norma UNE 23727.

| | Módulo | Puerta | Nº de Puertas | Medidas exterior total | Hueco útil por taquilla | Ref. | Euros | Accesorios incluidos |
|--|--------|--------|---------------|-------------------------|-------------------------|--------|---------|----------------------|
| | M1 | P1 | 1 | 39,5 x 53,7 x 191,5 cm | 34,6 x 48,9 x 174 cm | K4M1P1 | 434,00 | |
| | M2 | P1 | 2 | 76,2 x 53,7 x 191,5 cm | 34,6 x 48,9 x 174 cm | K4M2P1 | 787,00 | |
| | M3 | P1 | 3 | 112,9 x 53,7 x 191,5 cm | 34,6 x 48,9 x 174 cm | K4M3P1 | 1139,00 | |
| | M4 | P1 | 4 | 149,6 x 53,7 x 191,5 cm | 34,6 x 48,9 x 174 cm | K4M4P1 | 1492,00 | 1/2 Estante y barra |
| | M5 | P1 | 5 | 186,3 x 53,7 x 191,5 cm | 34,6 x 48,9 x 174 cm | K4M5P1 | 1845,00 | |
| | M6 | P1 | 6 | 223 x 53,7 x 191,5 cm | 34,6 x 48,9 x 174 cm | K4M6P1 | 2199,00 | |
| | M1 | P2 | 2 | 39,5 x 53,7 x 191,5 cm | 34,6 x 48,9 x 85,9 cm | K4M1P2 | 517,00 | |
| | M2 | P2 | 4 | 76,2 x 53,7 x 191,5 cm | 34,6 x 48,9 x 85,9 cm | K4M2P2 | 958,00 | |
| | M3 | P2 | 6 | 112,9 x 53,7 x 191,5 cm | 34,6 x 48,9 x 85,9 cm | K4M3P2 | 1401,00 | |
| | M4 | P2 | 8 | 149,6 x 53,7 x 191,5 cm | 34,6 x 48,9 x 85,9 cm | K4M4P2 | 1844,00 | Barra de colgar |
| | M5 | P2 | 10 | 186,3 x 53,7 x 191,5 cm | 34,6 x 48,9 x 85,9 cm | K4M5P2 | 2287,00 | |
| | M6 | P2 | 12 | 223 x 53,7 x 191,5 cm | 34,6 x 48,9 x 85,9 cm | K4M6P2 | 2728,00 | |
| | M1 | P3 | 3 | 39,5 x 53,7 x 191,5 cm | 34,6 x 48,9 x 56,5 cm | K4M1P3 | 598,00 | |
| | M2 | P3 | 6 | 76,2 x 53,7 x 191,5 cm | 34,6 x 48,9 x 56,5 cm | K4M2P3 | 1109,00 | |
| | M3 | P3 | 9 | 112,9 x 53,7 x 191,5 cm | 34,6 x 48,9 x 56,5 cm | K4M3P3 | 1666,00 | |
| | M4 | P3 | 12 | 149,6 x 53,7 x 191,5 cm | 34,6 x 48,9 x 56,5 cm | K4M4P3 | 2194,00 | |
| | M5 | P3 | 15 | 186,3 x 53,7 x 191,5 cm | 34,6 x 48,9 x 56,5 cm | K4M5P3 | 2720,00 | |
| | M6 | P3 | 18 | 223 x 53,7 x 191,5 cm | 34,6 x 48,9 x 56,5 cm | K4M6P3 | 3273,00 | |
| | M1 | P4 | 4 | 39,5 x 53,7 x 191,5 cm | 34,6 x 48,9 x 41,8 cm | K4M1P4 | 688,00 | |
| | M2 | P4 | 8 | 76,2 x 53,7 x 191,5 cm | 34,6 x 48,9 x 41,8 cm | K4M2P4 | 1283,00 | |
| | M3 | P4 | 12 | 112,9 x 53,7 x 191,5 cm | 34,6 x 48,9 x 41,8 cm | K4M3P4 | 1968,00 | |
| | M4 | P4 | 16 | 149,6 x 53,7 x 191,5 cm | 34,6 x 48,9 x 41,8 cm | K4M4P4 | 2594,00 | |
| | M5 | P4 | 20 | 186,3 x 53,7 x 191,5 cm | 34,6 x 48,9 x 41,8 cm | K4M5P4 | 3218,00 | |
| | M6 | P4 | 24 | 223 x 53,7 x 191,5 cm | 34,6 x 48,9 x 41,8 cm | K4M6P4 | 3870,00 | |
| | M1 | P5 | 5 | 39,5 x 53,7 x 191,5 cm | 34,6 x 48,9 x 33 cm | K4M1P5 | 779,00 | |
| | M2 | P5 | 10 | 76,2 x 53,7 x 191,5 cm | 34,6 x 48,9 x 33 cm | K4M2P5 | 1460,00 | |
| | M3 | P5 | 15 | 112,9 x 53,7 x 191,5 cm | 34,6 x 48,9 x 33 cm | K4M3P5 | 2277,00 | |
| | M4 | P5 | 20 | 149,6 x 53,7 x 191,5 cm | 34,6 x 48,9 x 33 cm | K4M4P5 | 3004,00 | |
| | M5 | P5 | 25 | 186,3 x 53,7 x 191,5 cm | 34,6 x 48,9 x 33 cm | K4M5P5 | 3731,00 | |
| | M6 | P5 | 30 | 223 x 53,7 x 191,5 cm | 34,6 x 48,9 x 33 cm | K4M6P5 | 4484,00 | |

NOTA: Las taquillas se suministran desmontadas, techo, suelo, laterales y fondo. El ensamblaje se realiza, encajando los dos laterales al fondo y uniendo mediante 12 tornillos el techo, el suelo y la puerta (tiempo 5 min.).

10 TAQUILLAS

GAMA 400 D Vertical
Cerradura de tipo pitones con 3.120 n° de combinaciones.
Cierre central y posibilidad de amaestramiento.
Color carcás en gris.
Color de la puerta en azul, rojo, beige o gris claro.

Material resinas de polivinilo.
Patas regulables de 13 a 18 cms.
Clasificación M1 según norma UNE 23727.

GAMA 400 D Vertical
 Cerradura de tipo pitones con 3.120 n° de combinaciones.
 Cierre central y posibilidad de amaestramiento.
 Color carcás en gris.
 Color de la puerta en azul, rojo, beige o gris claro.

Material resinas de polivinilo.
 Patas regulables de 13 a 18 cms.
 Clasificación M1 según norma UNE 23727.

GAMA 400 D Vertical
 Cerradura de tipo pitones con 3.120 n° de combinaciones.
 Cierre central y posibilidad de amaestramiento.
 Color carcás en gris.
 Color de la puerta en azul, rojo, beige o gris claro.

Material resinas de polivinilo.
 Patas regulables de 13 a 18 cms.
 Clasificación M1 según norma UNE 23727.

| | Módulo | Puerta | N° de Puertas | Medidas exterior total | Hueco útil por taquilla | Ref. | Euros | Accesorios incluidos |
|--|--------|--------|---------------|-------------------------|-------------------------|---------|---------|------------------------------------|
| | M1 | P1 | 1 | 39,5 x 53,7 x 191,5 cm | 16,2 x 48,9 x 174 cm | KD4M1P1 | 542,00 | Estante, barra y división vertical |
| | M2 | P1 | 2 | 76,2 x 53,7 x 191,5 cm | 16,2 x 48,9 x 174 cm | KD4M2P1 | 1003,00 | |
| | M3 | P1 | 3 | 112,9 x 53,7 x 191,5 cm | 16,2 x 48,9 x 174 cm | KD4M3P1 | 1463,00 | |
| | M4 | P1 | 4 | 148,7 x 53,7 x 191,5 cm | 16,2 x 48,9 x 174 cm | KD4M4P1 | 1924,00 | |
| | M5 | P1 | 5 | 186,3 x 53,7 x 191,5 cm | 16,2 x 48,9 x 174 cm | KD4M5P1 | 2385,00 | |
| | M6 | P1 | 6 | 223 x 53,7 x 191,5 cm | 16,2 x 48,9 x 174 cm | KD4M6P1 | 2848,00 | |
| | M1 | P2 | 2 | 39,5 x 53,7 x 191,5 cm | 16,2 x 48,9 x 85,9 cm | KD4M1P2 | 631,00 | Barra y división vertical |
| | M2 | P2 | 4 | 75,7 x 53,7 x 191,5 cm | 16,2 x 48,9 x 85,9 cm | KD4M2P2 | 1187,00 | |
| | M3 | P2 | 6 | 112,2 x 53,7 x 191,5 cm | 16,2 x 48,9 x 85,9 cm | KD4M3P2 | 1743,00 | |
| | M4 | P2 | 8 | 148,7 x 53,7 x 191,5 cm | 16,2 x 48,9 x 85,9 cm | KD4M4P2 | 2299,00 | |
| | M5 | P2 | 10 | 155,2 x 53,7 x 191,5 cm | 16,2 x 48,9 x 85,9 cm | KD4M5P2 | 2856,00 | |
| | M6 | P2 | 12 | 221,7 x 53,7 x 191,5 cm | 16,2 x 48,9 x 85,9 cm | KD4M6P2 | 3412,00 | |

NOTA: Las taquillas se suministran desmontadas, techo, suelo, laterales y fondo. El ensamblaje se realiza, encajando los dos laterales al fondo y uniendo mediante 12 tornillos el techo, el suelo y la puerta (tiempo 5 min.).

| Accesorios | Precio PVP |
|------------------------------------|------------------|
| 1/2 Estante | 27,00 |
| 1 Estante | 38,00 |
| Barra de colgar | 17,50 |
| Patas regulables | <i>incluidas</i> |
| Zócalo 1 módulo lateral | 42,00 |
| Zócalo módulo central | 14,50 |
| Muñequera llave numerada | 15,00 |
| Numeración placa de 30 x15 | 8,00 |
| Techo inclinado 1 módulo laterales | 86,00 |
| Techo inclinado 1 módulo central | 43,00 |
| Cerradura de seguridad | CONSULTAR |
| Cerradura de monedas | 37,00 |

NOTA: Las taquillas se suministran desmontadas, techo, suelo, laterales y fondo. El ensamblaje se realiza, encajando los dos laterales al fondo y uniendo mediante 12 tornillos el techo, el suelo y la puerta (tiempo 5 min.).

Recambios

FAMILIA 2

Carteles portaprecios

FAMILIA 4

Soldadoras de bolsas

Máquinas retractilar

FAMILIA5

Esterilizadores

FAMILIA 6

Indicadores de turno

Exterminadores-tubos

FAMILIA 7

Hamburguesera

FAMILIA 8

Máquinas cierrabolsas

Etiquetadoras

FAMILIA 9

Guantes de acero inoxidable

Abrelatas

FAMILIA 2

CARTELES PORTAPRECIOS

Números

| Ref. | Para | Euros |
|-------|--|-------|
| C-103 | C-26 | 1,20 |
| C-104 | C-27, C-28, C-50 | 1,20 |
| C-108 | C-19, C-20, C-21, C-25, C-35, C-40, C-41, C-52 | 1,40 |
| C-110 | C-31, C-32, C-33 | 2,40 |
| C-115 | C-30, C-34 | 4,35 |
| C-123 | Cartel UVI | 4,00 |

Números (Caja 24 juegos números / Ref. C-121 números dobles)

| Ref. | Para | Euros |
|-------|------|-------|
| C-121 | C-44 | 34,00 |
| C-122 | C-42 | 27,00 |

FAMILIA 4

SOLDADORES DE BOLSAS

Resistencia y teflón

| Ref. | Para | Euros |
|--------|--------|-------|
| SB-201 | SB-200 | 13,00 |
| SB-301 | SB-300 | 13,00 |
| SB-401 | SB-400 | 13,00 |
| SB-501 | SB-500 | 15,00 |

Termóstato

| Ref. | Para | Euros |
|--------|--------|-------|
| SB-202 | SB-200 | 57,50 |
| SB-302 | SB-300 | 57,50 |
| SB-402 | SB-400 | 57,50 |
| SB-502 | SB-500 | 60,00 |

Resistencia

| Ref. | Para | Euros |
|---------|--------------------------|-------|
| SB-451 | SBP-450 | 17,50 |
| SB-601 | SBP-600, SBM-600, SB-600 | 19,00 |
| SB-1001 | SB-1000 | 25,50 |

Resistencia

| Ref. | Para | Euros |
|----------|----------|-------|
| SBPA-451 | SBPA-450 | 26,50 |
| SBPA-601 | SBPA-600 | 30,00 |

Rollo teflón

| Ref. | Para | Euros |
|--------|----------------------|-------|
| SB-602 | SBP-450/600, SBM-600 | 53,00 |

MÁQUINAS DE RETRACTILAR

Resistencia de corte

| Ref. | Para | Euros |
|------------|--------------|-------|
| MR-201 | MR-2, MR-4 | 47,50 |
| MR-201-ECO | MR-4-ECO | 43,00 |
| MR-206 | MR-4-500 | 49,00 |
| MR-206-ECO | MR-4-500-ECO | 45,00 |

Resistencia de corte

| Ref. | Para | Euros |
|--------|----------|-------|
| MR-210 | MR-4-600 | 51,00 |
| MR-215 | MR-3 | 36,00 |

Placa de calor

| Ref. | Para | Euros |
|------------|----------------|-------|
| MR-202 | MR-4, MR-4-500 | 85,00 |
| MR-202-ECO | MR-4-ECO | 60,00 |

Termostato

| Ref. | Para | Euros |
|------------|------------------------|-------|
| MR-203 | MR-4, MR-4-500 | 24,50 |
| MR-203-ECO | MR-4-ECO, MR-4-500-ECO | 23,00 |

Rueda termostato

| Ref. | Para | Euros |
|--------|----------------|-------|
| MR-204 | MR-4, MR-4-500 | 8,00 |

Portafusible con fusible

| Ref. | Para | Euros |
|--------|----------------|-------|
| MR-205 | MR-4, MR-4-500 | 5,50 |

Interruptor general

| Ref. | Para | Euros |
|--------|----------------|-------|
| MR-207 | MR-4, MR-4-500 | 19,00 |

Interruptor placa de calor o resistencia

| Ref. | Para | Euros |
|--------|----------------|-------|
| MR-208 | MR-4, MR-4-500 | 9,50 |

Piloto señalización

| Ref. | Para | Euros |
|--------|----------------|-------|
| MR-209 | MR-4, MR-4-500 | 8,50 |

ESTERILIZADORES

Circuito eléctrico completo temporizado

| Ref. | Para | Euros |
|---------------|---------------------|---------------|
| EC-710 | EC-1, EC-55, EC-105 | 218,00 |

Base conexión macho con toma red + portafusible

| Ref. | Para | Euros |
|---------------|---------------------|--------------|
| EC-711 | EC-1, EC-55, EC-105 | 33,50 |

Pulsador redondo para encendido

| Ref. | Para | Euros |
|---------------|---------------------|-------------|
| EC-712 | EC-1, EC-55, EC-105 | 7,00 |

Cable de corriente

| Ref. | Para | Euros |
|---------------|---------------------|-------------|
| EC-713 | EC-1, EC-55, EC-105 | 7,50 |

Fusible

| Ref. | Para | Euros |
|---------------|---------------------|-------------|
| EC-714 | EC-1, EC-55, EC-105 | 2,00 |

Lámpara ozono con soporte

| Ref. | Para | Euros |
|---------------|---------------------|--------------|
| EC-715 | EC-1, EC-55, EC-105 | 38,00 |

Lámpara UV germicida 15 W

| Ref. | Para | Euros |
|---------------|-------------------------|--------------|
| ECU-15 | ECU-25, ECU-50, ECU-100 | 53,00 |

INDICADORES DE TURNO

Soporte pared

| Ref. | Para | Euros |
|---------------|------|-------------|
| ET-108 | ET-1 | 7,00 |

Caja control

| Ref. | Para | Euros |
|---------------|------------|--------------|
| IT-103 | IT-4, IT-6 | 67,00 |

Caja control

| Ref. | Para | Euros |
|---------------|------|--------------|
| IT-110 | IT-8 | 59,00 |

Mando a distancia

| Ref. | Para | Euros |
|---------------|---------|--------------|
| IT-105 | IT-5-MD | 52,00 |

Mando a distancia

| Ref. | Para | Euros |
|----------------|---------|--------------|
| IT-105- | IT-7-MD | 52,00 |

Mando a distancia con visor

| Ref. | Para | Euros |
|-----------------|----------|--------------|
| IT-105-V | IT-5-MDV | 77,00 |

Mando a distancia (1 función)

| Ref. | Para | Euros |
|---------------|---------------------------|--------------|
| IT-107 | IT-4-MD, IT-6-MD, IT-5-MD | 51,00 |

Mando a distancia (2 funciones)

| Ref. | Para | Euros |
|---------------|------------------|--------------|
| IT-106 | IT-6-MD, IT-8-MD | 66,00 |

Mando a distancia (3 funciones)

| Ref. | Para | Euros |
|---------------|---------|--------------|
| IT-109 | IT-4-MD | 71,00 |

FAMILIA 6

EXTERMINADORES-TUBOS

Tubo

| Ref. | Tipo | Para | Euros |
|--------|------|-------------------------------|-------|
| Z-10 | 10 W | Z-420-MD | 12,00 |
| Z-11 | 11 W | Z-600 | 12,50 |
| Z-15 | 15 W | Z-700, Z-930, Z-950, Z-430-MD | 14,00 |
| Z-20 | 20 W | Z-740, Z-840, Z-960 | 15,00 |
| Z-20-F | 18 W | Z-440-MD | 19,00 |
| Z-40 | 40 W | Z-780, Z-880 | 18,00 |

Tubo, forma U

| Ref. | Tipo | Para | Euros |
|--------|------|-------|-------|
| Z-11-U | 11 W | Z-151 | 11,50 |

Lámpara bajo consumo

| Ref. | Tipo | Para | Euros |
|------|------|--------------|-------|
| Z-21 | 20 W | Z-911, Z-918 | 19,00 |

Tubos LED

| Ref. | Tipo | Para | Euros |
|--------|-------|--|-------|
| ZT-4.5 | 4.5 W | Z-600 | 12,00 |
| ZT-6.5 | 6.5 W | Z-420-MD | 13,00 |
| ZT-7 | 7 W | Z-430-MD, Z-700, Z-700-ECO, Z-931, Z-940 | 14,00 |
| ZT-10 | 10 W | Z-440-MD, Z-740 | 17,00 |

Lámpara LED

| Ref. | Tipo | Para | Euros |
|------|------|--------------|-------|
| ZL-7 | 7 W | Z-918, A-911 | 19,00 |

FAMILIA 7

HAMBURGUESERAS

Palanca prensa

| Ref. | Para | Euros |
|--------|------|-------|
| MH-101 | MH-2 | 82,50 |

Pala doble

| Ref. | Para | Euros |
|--------|------------|-------|
| MH-102 | MH-2 | 82,50 |
| MH-105 | MH-3, MH-4 | 60,50 |

Pala doble redonda

| Ref. | Para | Euros |
|--------|------|-------|
| MH-107 | MH-5 | 60,50 |
| MH-6-1 | MH-6 | 61,00 |
| MH-7-1 | MH-7 | 66,00 |
| MH-8-1 | MH-8 | 83,00 |
| MH-9-1 | MH-9 | 83,00 |

Pala ovalada

| Ref. | Para | Euros |
|--------|------|-------|
| MH-111 | MH-1 | 15,00 |

Pala redonda

| Ref. | Para | Euros |
|--------|--------|-------|
| MH-112 | MH-1-R | 16,00 |

Muelle elevación placa

| Ref. | Para | Euros |
|--------|------------|-------|
| MH-104 | MH-2 | 6,00 |
| MH-110 | MH-3, MH-4 | 6,00 |

Muelle elevación brazo

| Ref. | Para | Euros |
|--------|------|-------|
| MH-103 | MH-2 | 6,00 |

Muelle elevación brazo izquierdo

| Ref. | Para | Euros |
|--------|------------|-------|
| MH-108 | MH-3, MH-4 | 6,00 |

Muelle elevación brazo derecho

| Ref. | Para | Euros |
|--------|------------|-------|
| MH-109 | MH-3, MH-4 | 6,00 |

FAMILIA 8
MÁQUINAS CIERRA BOLSAS

Rueda rollo

| Ref. | Para | Euros |
|-------|--------|-------|
| CB-10 | CB-101 | 4,00 |

Rueda rollo

| Ref. | Para | Euros |
|-------|--------|-------|
| CB-11 | CB-606 | 4,00 |

ETIQUETADORAS

Rodillo tinta







| Ref. | Para | Euros |
|-------|----------|-------|
| E-110 | E-5, E-6 | 6,00 |

Rodillo tinta

| Ref. | Para | Euros |
|-----------|------------------|-------|
| E-110-ECO | E-5-ECO, E-6-ECO | 6,00 |

FAMILIA 9
GUANTES ACERO INOXIDABLE

Banda plástico

| Ref. | Color | Euros | Ref. | Color | Euros |
|----------|---|-------|----------|---|-------|
| A-1050-B |  | 9,00 | A-1053-B |  | 9,00 |
| A-1051-B |  | 9,00 | A-1054-B |  | 9,00 |
| A-1052-B |  | 9,00 | A-1055-B |  | 9,00 |

Cuchilla

| Ref. | Para | Euros |
|--------|------|-------|
| A-70-1 | A-70 | 8,00 |

Roldana o rueda de arrastre

| Ref. | Para | Euros |
|--------|------|-------|
| A-70-2 | A-70 | 13,00 |

Muelle de roldana

| Ref. | Para | Euros |
|--------|------|-------|
| A-70-3 | A-70 | 6,00 |

Anexos



SUBDIRECCIÓN GENERAL
DE GESTIÓN DE RIESGOS
ALIMENTARIOS
REGISTRO GENERAL
SANITARIO DE ALIMENTOS

1/1

| | | | |
|----|--|-------------------------------|--|
| 1. | Nombre o Razón Social SACOPISA S.L. | | |
| 2. | Domicilio Social C/ VALLES 5 (POL. IND. CAN CASABLANCAS) SANT QUIRZE DEL VALLES | | BARCELONA |
| 3. | Actividad de la Industria FABRICACION Y/O ELABORACION Y/O TRANSFORMACION DE MATERIAS PLASTICAS FABRICACION Y/O ELABORACION Y/O TRANSFORMACION DE MADERA, CORCHO, CUERO, PIELS Y FIBRAS NATURALES | | |
| 4. | Domicilio Industrial C/ VALLES 5 (POL. IND. CAN CASABLANCAS) SANT QUIRZE DEL VALLES | | BARCELONA |
| 5. | Clave 39 | Categ. / Act./s 0101, 0109 | Núm. Registro Sanitario 39.04434/B |

De conformidad con lo dispuesto en el artículo segundo del Real Decreto 1712/1991, de 29 de noviembre (B.O.E. de 4 de diciembre), y a tenor de la autorización concedida, ha quedado inscrita la industria de referencia en el Registro General Sanitario de Alimentos con el número arriba indicado.

Madrid, 22 de Octubre de 2010

EL TÉCNICO SUPERIOR



REGISTRO GENERAL SANITARIO
DE ALIMENTOS

Miguel Ángel Casas Paulet

AREA DE AUTORIZACIONES Y REGISTROS (DIVISION DE GESTION DE RIESGOS)
AGENCIA DE PROTECCION DE LA SALUD
BARCELONA

Generalitat de Catalunya
Agència de Salut Pública de Catalunya

SACOPI SA SL
Polígon Industrial Can Casablanques sortida
CR Vallès, 5
08192 SANT QUIRZE DEL VALLÈS

D'acord amb la sol·licitud presentada i havent tramitat l'expedient corresponent, ha quedat **ACTUALITZADA** la situació de l'empresa de referència en el Registre sanitari d'indústries i productes alimentaris de Catalunya (RSIPAC), amb les dades següents:

De conformidad con la solicitud presentada y tramitado el expediente correspondiente, ha quedado **ACTUALIZADA** la situación de la empresa de referencia en el Registro Sanitario de Industrias y Productos Alimentarios de Cataluña (RSIPAC), con los datos siguientes:

IDENTIFICACIÓ DE L'EMPRESA/IDENTIFICACIÓN DE LA EMPRESA

Raó social/razón social: SACOPI SA SL
NIF/NIE/CIF: B60206810

Adreça social/domicili social: Polígon Industrial Can Casablanques
CR Vallès, 5
08192 SANT QUIRZE DEL VALLÈS
X: 423992
Y: 4600634

Adreça industrial/domicili industrial: Polígon Industrial Can Casablanques
CR Vallès, 5
08192 SANT QUIRZE DEL VALLÈS
X: 423992
Y: 4600634

Núm. RSIPAC: 39.05165/CAT Núm. RGSEAA: 39.04434/B

Data Inscripció/fecha inscripción: 07/09/2010

ACTIVITATS / ACTIVIDADES

Ciau: 39

| Codi | Descripció |
|-------|---|
| 01/01 | Fabricació o elaboració o transformació de matèries plàstiques |
| 01/09 | Fabricació o elaboració o transformació de fusta, suro, cuir, pells i fibres naturals |

Clave: 39

| Código | Descripción |
|--------|--|
| 01/01 | Fabricación o elaboración o transformación de materias plásticas |
| 01/09 | Fabricación o elaboración o transformación de madera, corcho, cuero, pieles y fibras naturales |

Roc Boronat, 81-95
Barcelona . 93 551 39 00 / Fax 93 551 75 05
<http://www.gencat.cat/salut>

SALUT



Document electrònic garantit amb signatura electrònica. Podeu verificar la integritat d'aquest document a l'adreça web csv.gencat.cat

Original electrònic / Còpia autèntica

Doc.original signat per:
CPI/SR-1 Maria Alba Pascual
Cardona
12/07/2016

CODI SEGUR DE VERIFICACIÓ

01DBVIPDK3N0IMSEB1W8U23LY2J4NUHL

Data creació còpia:
13/07/2016
Data caducitat còpia:
13/07/2019
Pàgina 1 de 2

Index

201 - 207

0-B**0-9**

| | |
|----------|-----|
| 0010.100 | 162 |
| 0015.065 | 162 |
| 0151.310 | 156 |
| 0151.355 | 156 |
| 0151.395 | 156 |
| 0170.155 | 156 |
| 0170.185 | 156 |
| 0170.210 | 156 |
| 0170.260 | 156 |
| 0170.310 | 156 |
| 0170.355 | 156 |
| 0170.395 | 156 |
| 0370.165 | 160 |
| 0370.195 | 160 |
| 0370.225 | 160 |
| 0425.130 | 156 |
| 0425.150 | 156 |
| 0430.150 | 156 |
| 0500.305 | 158 |
| 0521.250 | 158 |
| 0521.300 | 158 |
| 0526.250 | 158 |
| 0526.300 | 158 |
| 0540.250 | 158 |
| 0540.305 | 158 |
| 0560.310 | 159 |
| 0575.250 | 161 |
| 0575.300 | 161 |
| 0575.360 | 161 |
| 0600.300 | 160 |
| 0600.350 | 160 |
| 0701.320 | 159 |
| 0701.350 | 159 |
| 0701.370 | 159 |
| 0720.350 | 159 |
| 0720.380 | 159 |
| 0775.190 | 159 |
| 0801.230 | 157 |
| 0801.250 | 157 |
| 0801.290 | 157 |
| 0820.240 | 157 |
| 0820.260 | 157 |
| 0840.320 | 157 |
| 0850.220 | 157 |
| 0850.250 | 157 |
| 0901.290 | 157 |
| 0901.310 | 157 |
| 0905.290 | 157 |
| 0905.310 | 157 |
| 1000.305 | 161 |
| 1000.450 | 161 |
| 1001.260 | 161 |
| 1001.290 | 161 |
| 1001.320 | 161 |
| 1701.135 | 162 |
| 1705.150 | 162 |
| 2002.250 | 161 |
| 2002.310 | 161 |
| 2401.230 | 162 |
| 2401.260 | 162 |
| 2460.400 | 168 |
| 2460.450 | 168 |
| 2460.500 | 168 |
| 2476.420 | 168 |
| 2476.450 | 168 |
| 2476.500 | 168 |
| 2500.330 | 168 |
| 2500.450 | 168 |
| 2500.600 | 168 |
| 2526.000 | 159 |
| 3000.200 | 164 |
| 3000.250 | 164 |
| 3000.300 | 164 |
| 3050.300 | 164 |
| 3100.300 | 164 |
| 3150.300 | 164 |

| | |
|-------------|-----|
| 3200.300-A | 164 |
| 3200.300-AZ | 164 |
| 3200.300-N | 164 |
| 3200.300-R | 164 |
| 3200.300-V | 164 |
| 3250.300-A | 164 |
| 3250.300-AZ | 164 |
| 3250.300-N | 164 |
| 3250.300-R | 164 |
| 3250.300-V | 164 |
| 3400.300 | 164 |
| 3500.300 | 164 |
| 3900.650 | 163 |
| 3900.700 | 163 |
| 3900.750 | 163 |
| 3900.995 | 163 |
| 4000.100 | 160 |
| 4000.150 | 160 |
| 4000.200 | 160 |
| 4000.250 | 160 |
| 4000.300 | 160 |
| 4010.150 | 160 |
| 4020.300 | 158 |
| 4050.180 | 160 |
| 4100.150 | 160 |
| 4100.200 | 160 |
| 4100.250 | 160 |
| 4101.250 | 160 |
| 4102.230 | 161 |
| 4105.180 | 159 |
| 4120.250 | 158 |
| 4120.300 | 158 |
| 4200.150 | 160 |
| 4200.200 | 160 |
| 4200.250 | 160 |
| 4200.280 | 160 |
| 4300.270 | 162 |

A

| | |
|-------------|-----|
| A-1 | 39 |
| A-2 | 168 |
| A-3 | 138 |
| A-4-11 | 140 |
| A-4-14 | 140 |
| A-4-16 | 140 |
| A-4-20 | 140 |
| A-4-24 | 140 |
| A-5-12 | 140 |
| A-5-16 | 140 |
| A-5-20 | 140 |
| A-5-24 | 140 |
| A-6 | 166 |
| A-8 | 140 |
| A-9-76M | 174 |
| A-11-90 | 174 |
| A-11-90-AZ | 174 |
| A-11-90-N | 174 |
| A-11-90-R | 174 |
| A-11-110 | 174 |
| A-11-110-AZ | 174 |
| A-11-120-AZ | 174 |
| A-12 | 175 |
| A-14 | 167 |
| A-15 | 142 |
| A-16 | 166 |
| A-17-B | 175 |
| A-17-BAZ | 175 |
| A-17-BR | 175 |
| A-17-BU | 175 |
| A-17-BV | 175 |
| A-17-F | 175 |
| A-17-N | 175 |
| A-17-NBU | 175 |
| A-17-NV | 175 |
| A-17-P | 175 |
| A-18 | 168 |
| A-20 | 140 |
| A-21 | 167 |

| | |
|--------------------|-----|
| A-22 | 167 |
| A-23 | 140 |
| A-24 | 140 |
| A-25 | 165 |
| A-26 | 140 |
| A-27 | 138 |
| A-28 | 138 |
| A-30-50 | 21 |
| A-30-50-I | 21 |
| A-30-70 | 21 |
| A-30-70-I | 21 |
| A-30-100 | 21 |
| A-30-100-I | 21 |
| A-35-13 | 71 |
| A-35-15 | 71 |
| A-35-26 | 71 |
| A-36-11 | 71 |
| A-36-13 | 71 |
| A-36-15 | 71 |
| A-37 | 135 |
| A-41 | 20 |
| A-42 | 20 |
| A-43 | 20 |
| A-44 | 20 |
| A-46 | 20 |
| A-47 | 20 |
| A-48-18 | 15 |
| A-48-22 | 15 |
| A-48-26 | 15 |
| A-49 | 141 |
| A-50 | 141 |
| A-50-15 | 141 |
| A-50-25 | 141 |
| A-50-30 | 141 |
| A-51 | 167 |
| A-52 | 167 |
| A-53 | 167 |
| A-54 | 167 |
| A-56 | 168 |
| A-57 | 21 |
| A-70 | 169 |
| A-70-1 | 195 |
| A-70-2 | 195 |
| A-70-3 | 195 |
| A-75 | 92 |
| A-76 | 92 |
| A-77 | 92 |
| A-80 | 7 |
| A-81 | 7 |
| A-81-1 | 7 |
| A-81-4 | 7 |
| A-90 | 109 |
| A-90 | 153 |
| A-95 | 109 |
| A-198 | 82 |
| A-198-1 | 82 |
| A-200 | 83 |
| A-200-13 | 83 |
| A-200-13X Circonio | 83 |
| A-200-33 | 83 |
| A-530 | 128 |
| A-531 | 128 |
| A-540 | 128 |
| A-550 | 128 |
| A-555 | 128 |
| A-760-8 | 173 |
| A-760-9 | 173 |
| A-760-10 | 173 |
| A-760-11 | 173 |
| A-1000 | 171 |
| A-1020 | 171 |
| A-1021 | 171 |
| A-1022 | 171 |
| A-1023 | 171 |
| A-1024 | 171 |
| A-1050-B | 195 |
| A-1050-X | 170 |

| | |
|-----------|-----|
| A-1051-B | 195 |
| A-1051-X | 170 |
| A-1052-B | 195 |
| A-1052-X | 170 |
| A-1053-B | 195 |
| A-1053-X | 170 |
| A-1054-B | 195 |
| A-1054-X | 170 |
| A-1055-B | 195 |
| A-1055-X | 170 |
| A-1110 | 171 |
| A-1111 | 171 |
| A-1112 | 171 |
| A-1113 | 171 |
| A-1114 | 171 |
| A-1115 | 171 |
| A-1150 | 170 |
| A-1151 | 170 |
| A-1152 | 170 |
| A-1153 | 170 |
| A-1154 | 170 |
| A-1155 | 170 |
| A-2001 | 172 |
| A-2002 | 172 |
| A-2003 | 172 |
| A-2004 | 172 |
| A-3000 | 173 |
| A-3000-AZ | 173 |
| A-3005 | 173 |
| A-3005-AZ | 173 |
| A-5548 | 172 |
| A-8533 | 172 |
| A-8633 | 172 |

B

| | |
|---------|-----|
| BAC-1 | 47 |
| BAC-1 | 150 |
| BAC-2 | 47 |
| BAC-2 | 150 |
| BB-1 | 46 |
| BB-2 | 46 |
| BB-3 | 46 |
| BB-4 | 46 |
| BB-5 | 46 |
| BB-6 | 46 |
| BB-7 | 46 |
| BB-8 | 46 |
| BB-9 | 46 |
| BB-10 | 46 |
| BBP-1 | 46 |
| BBP-2 | 46 |
| BBP-3 | 46 |
| BBP-4 | 46 |
| BBP-5 | 46 |
| BC-0 | 48 |
| BC-0-N | 48 |
| BC-1 | 48 |
| BC-1-N | 48 |
| BC-2 | 48 |
| BC-2-N | 48 |
| BC-3 | 48 |
| BC-3-N | 48 |
| BC-4 | 48 |
| BC-4-N | 48 |
| BC-5 | 48 |
| BCR-0 | 48 |
| BCR-1 | 48 |
| BCR-2 | 48 |
| BCR-3 | 48 |
| BCR-4 | 48 |
| BCR-5 | 48 |
| BCR-5-N | 48 |
| BCT-0 | 48 |
| BCT-1 | 48 |
| BCT-2 | 48 |
| BCT-3 | 48 |
| BI-11 | 49 |
| BI-12 | 49 |

| | | | | | | | |
|----------------|-----|--------------|----|----------|-----|------------|-----|
| BI-13 | 49 | BPT-1/4-T | 56 | C-7-B | 30 | C-215-N | 36 |
| BI-14 | 49 | BPT-1/5-T | 56 | C-9 | 36 | C-215-N | 60 |
| BI-15-B | 49 | BPT-2/5-T | 56 | C-10 | 28 | C-300 | 26 |
| BI-15-B | 150 | BPT-3/4-T | 56 | C-10-AZ | 28 | C-301 | 26 |
| BI-15-N | 49 | BPT-4015 | 59 | C-10-B | 28 | C-302 | 26 |
| BI-15-N | 150 | BPT-6680 | 59 | C-11 | 28 | C-303 | 26 |
| BI-15-R | 49 | BPTR-27-20-N | 56 | C-11-AZ | 28 | C-304 | 26 |
| BI-15-R | 150 | BPTR-40-20-N | 56 | C-11-B | 28 | C-305 | 26 |
| BI-21 | 49 | BPTR-40-50-N | 56 | C-24 | 32 | C-306 | 26 |
| BI-21-N | 49 | BV-140450 | 94 | C-24-B | 32 | C-307 | 26 |
| BI-22 | 49 | BV-150200 | 94 | C-24-T | 32 | C-310 | 27 |
| BI-22-N | 49 | BV-150250 | 94 | C-39 | 33 | C-311 | 27 |
| BI-23 | 49 | BV-175250 | 94 | C-44-AZ | 31 | C-312 | 27 |
| BI-23-N | 49 | BV-180300 | 94 | C-44-B | 31 | C-313 | 27 |
| BP-1946-N | 60 | BV-200200 | 94 | C-44-BAZ | 31 | C-314 | 27 |
| BP-4013-N | 59 | BV-200250 | 94 | C-44-BR | 31 | C-315 | 27 |
| BP-5355-N | 59 | BV-200300 | 94 | C-44-BV | 31 | C-317 | 27 |
| BP-5356-N | 60 | BV-200350 | 94 | C-44-C | 31 | C-320 | 27 |
| BP-5869-N | 60 | BV-200400 | 94 | C-44-M | 31 | C-320 | 34 |
| BP-5921-N | 60 | BV-250350 | 94 | C-44-R | 31 | C-321 | 32 |
| BP-6661-N | 59 | BV-300400 | 94 | C-51 | 28 | C-500 | 37 |
| BP-6665-N | 59 | BV-350500 | 94 | C-56 | 31 | CB-10 | 195 |
| BP-6670-N | 59 | BV-350600 | 94 | C-65-AZ | 29 | CB-11 | 195 |
| BP-6675-N | 59 | BV-400500 | 94 | C-65-AZB | 29 | CB-101 | 146 |
| BP-6901-N | 60 | BV-400600 | 94 | C-65-B | 29 | CB-800 | 146 |
| BP-6960-N | 59 | BVC-150200 | 94 | C-65-BB | 29 | CC-9 | 44 |
| BP-9327-N | 60 | BVC-185250 | 94 | C-65-R | 29 | CC-10 | 44 |
| BP-10063-N | 59 | BVC-200300 | 94 | C-65-RB | 29 | CC-12 | 44 |
| BP-14330-N | 60 | BVC-250350 | 94 | C-65-V | 29 | CC-14 | 43 |
| BPA-15-50-N | 58 | BVC-300400 | 94 | C-65-VB | 29 | CC-15 | 44 |
| BPA-22G-50-N | 57 | BVC-350600 | 94 | C-66 | 30 | CC-16 | 44 |
| BPA-22P-50-N | 58 | BVE-200300 | 94 | C-66-B | 30 | CC-19 | 44 |
| BPA-45-50-N | 57 | BVE-250350 | 94 | C-67 | 33 | CC-20 | 44 |
| BPA-90-50-N | 57 | BVE-300400 | 94 | C-67-AZ | 33 | CC-21 | 44 |
| BPA-90-50-N | 58 | BVE-350450 | 94 | C-67-R | 33 | CC-32 | 43 |
| BPA-ANFI | 57 | BVE-350600 | 94 | C-72 | 34 | CC-33 | 44 |
| BPA-ANFI | 58 | BVE-400600 | 94 | C-73 | 34 | CC-40 | 44 |
| BPA-TD-50-N | 57 | BVP-175250 | 94 | C-76 | 34 | CC-60 | 44 |
| BPA-TD-50-N | 58 | BVP-175300 | 94 | C-76-C | 34 | CC-100 | 44 |
| BPA-TI-50-N | 57 | BVP-200250 | 94 | C-77 | 34 | CCT-39 | 44 |
| BPA-TI-50-N | 58 | BVP-200300 | 94 | C-77-C | 34 | CCT-40 | 44 |
| BPB-9232-N | 61 | BVX-1525 | 93 | C-81 | 33 | CCT-60 | 44 |
| BPB-10569-N | 61 | BVX-1535 | 93 | C-82 | 33 | CH-1 | 44 |
| BPB-17068-N | 61 | BVX-1545 | 93 | C-93 | 34 | CH-2 | 44 |
| BPB-17069-N | 61 | BVX-2020 | 93 | C-94 | 34 | CH-3 | 44 |
| BPB-17070-N | 61 | BVX-2030 | 93 | C-95 | 34 | CH-4 | 44 |
| BPB-17071-N | 61 | BVX-2040 | 93 | C-96 | 34 | CH-6 | 44 |
| BPB-25140 | 60 | BVX-2535 | 93 | C-97 | 33 | CH-7 | 44 |
| BPC-22860-N | 62 | BVX-3040 | 93 | C-97-N | 33 | CH-10 | 42 |
| BPC-22861-N | 62 | BVX-3050 | 93 | C-98 | 33 | CH-12 | 42 |
| BPC-22866-N | 62 | BVXC-200300 | 93 | C-98-N | 33 | CH-18 | 42 |
| BPC-24544-N | 62 | BVX-R15 | 93 | C-100 | 28 | CH-30 | 42 |
| BP-GN-1/1-17-N | 55 | BVX-R20 | 93 | C-103 | 192 | CH-40 | 42 |
| BP-GN 1/1-50-N | 55 | BVX-R25 | 93 | C-104 | 192 | CH-50 | 42 |
| BP-GN-1/2-17-N | 55 | BVX-R30 | 93 | C-108 | 192 | CH-75 | 42 |
| BP-GN 1/2-50-N | 55 | BVX-R40 | 93 | C-110 | 192 | CH-100 | 42 |
| BP-GN 1/3-17-N | 55 | BZ-1 | 45 | C-115 | 192 | CHT-50 | 42 |
| BP-GN 1/3-50-N | 55 | BZ-2 | 45 | C-121 | 192 | CHT-75 | 42 |
| BP-GN 1/4-17-N | 55 | BZ-3 | 45 | C-122 | 192 | CHT-100 | 42 |
| BP-GN 1/4-50-N | 55 | BZ-4 | 45 | C-123 | 192 | CP-8 | 72 |
| BP-GN 1/5-17-N | 55 | BZ-5 | 45 | C-130 | 30 | CP-8-3 | 72 |
| BP-GN 1/5-50-N | 55 | BZ-5 / BZ6 | 45 | C-131 | 30 | CP-8-3,5 | 72 |
| BP-GN 1/6-50-N | 55 | BZ-6 | 45 | C-132 | 30 | CP-8-4 | 72 |
| BP-GN 1/9-50-N | 55 | BZ-10 | 45 | C-140 | 33 | CP-8-4,5 | 72 |
| BP-GN 2/4-17-N | 55 | BZP-1 | 45 | C-141 | 33 | CP-8-5 | 72 |
| BP-GN 2/5-17-N | 55 | BZP-2 | 45 | C-200 | 35 | CP-8-6 | 72 |
| BP-GN 3/4-17-N | 55 | BZP-3 | 45 | C-201 | 35 | CP-8-7 | 72 |
| BP-GN 3/4-50-N | 55 | BZP-4 | 45 | C-202 | 35 | CP-8-8 | 72 |
| BP-GN 5/4-40-N | 55 | C | | C-203 | 35 | CP-12 | 72 |
| BPR-1/1-N | 56 | C-1 | 35 | C-205 | 35 | CP-12-3 | 72 |
| BPR-1/2-N | 56 | C-1-N | 35 | C-210 | 36 | CP-12- 3,5 | 72 |
| BPR-1/3-N | 56 | C-1-P | 35 | C-211 | 36 | CP-12-4 | 72 |
| BPR-1/4-N | 56 | C-1PN | 35 | C-212 | 36 | CP-12-4,5 | 72 |
| BPR-1/5-N | 56 | C-2 | 28 | C-213 | 36 | CP-12-5 | 72 |
| BPT-1/1-T | 56 | C-4-B | 35 | C-214 | 36 | CP-12-6 | 72 |
| BPT-1/2-T | 56 | C-4-M | 35 | C-215-B | 36 | CP-12-7 | 72 |
| BPT-1/3-T | 56 | C-7 | 30 | C-215-B | 60 | CP-12-8 | 72 |

C-K

| | | | | | | | |
|-----------|----|---------|-----|-------------|----|-------------|-----|
| CP-22 | 72 | EC-10 | 6 | GI-1/3-40 | 53 | GP-1/4-100 | 50 |
| CP-22-3 | 72 | EC-10 | 109 | GI-1/3-65 | 53 | GP-1/4-150 | 50 |
| CP-22-3,5 | 72 | EC-11 | 6 | GI-1/3-100 | 53 | GP-1/4-200 | 50 |
| CP-22-4 | 72 | EC-35 | 110 | GI-1/3-150 | 53 | GP-1/6-65 | 50 |
| CP-22-4,5 | 72 | EC-55 | 110 | GI-1/3-200 | 53 | GP-1/6-100 | 50 |
| CP-22-5 | 72 | EC-105 | 110 | GI-1/4-20 | 47 | GP-1/6-150 | 50 |
| CP-22-6 | 72 | EC-710 | 193 | GI-1/4-20 | 53 | GP-1/6-200 | 50 |
| CP-22-7 | 72 | EC-711 | 193 | GI-1/4-40 | 53 | GP-1/9-65 | 50 |
| CP-22-8 | 72 | EC-712 | 193 | GI-1/4-65 | 53 | GP-1/9-100 | 50 |
| CP-32 | 72 | EC-713 | 193 | GI-1/4-100 | 53 | GP-2/1-200 | 50 |
| CP-32-3 | 72 | EC-714 | 193 | GI-1/4-150 | 53 | GPFP-1/1 | 51 |
| CP-32-3,5 | 72 | EC-715 | 193 | GI-1/4-200 | 53 | GPFP-1/2 | 51 |
| CP-32-4 | 72 | ECU-15 | 193 | GI-1/6-65 | 53 | GPFP-2/1 | 51 |
| CP-32-4,5 | 72 | ECU-25 | 111 | GI-1/6-100 | 53 | GPT 1/1 | 51 |
| CP-32-5 | 72 | ECU-50 | 111 | GI-1/6-150 | 53 | GPT 1/2 | 51 |
| CP-32-6 | 72 | ECU-100 | 111 | GI-1/6-200 | 53 | GPT 1/3 | 51 |
| CP-32-7 | 72 | ET-1-A | 122 | GI-1/9-65 | 53 | GPT 1/4 | 51 |
| CP-32-8 | 72 | ET-1-AZ | 122 | GI-1/9-100 | 53 | GPT 1/6 | 51 |
| | | ET-1-B | 122 | GI-2/1-20 | 47 | GPT 1/9 | 51 |
| | | ET-1-G | 122 | GI-2/1-20 | 52 | GPT 2/1 | 51 |
| | | ET-1-N | 122 | GI-2/1-40 | 52 | | |
| | | ET-1-NA | 122 | GI-2/1-65 | 52 | H | |
| | | ET-1-R | 122 | GI-2/1-100 | 52 | H-12SR | 142 |
| | | ET-1-V | 122 | GI-2/1-150 | 52 | H-14SR | 142 |
| | | ET-10 | 122 | GI-2/1-200 | 52 | H-16SR | 142 |
| | | ET-15 | 122 | GI-2/3-20 | 47 | H-18SR | 142 |
| | | ET-108 | 193 | GI-2/3-20 | 52 | H-20SR | 142 |
| | | | | GI-2/3-40 | 52 | H-22R | 142 |
| | | | | GI-2/3-65 | 52 | H-24R | 142 |
| | | | | GI-2/3-100 | 52 | H-26R | 142 |
| | | | | GI-2/3-150 | 52 | H-28R | 142 |
| | | | | GI-2/3-200 | 52 | H-120NV | 142 |
| | | | | GIFP-1/1 | 54 | H-140NV | 142 |
| | | | | GIFP-1/2 | 54 | H-E10 | 142 |
| | | | | GIFP-2/1 | 54 | H-E12 | 142 |
| | | | | GIFP-2/3 | 54 | H-E14 | 142 |
| | | | | GIP-1/1-20 | 54 | H-E16 | 142 |
| | | | | GIP-1/1-40 | 54 | H-E18 | 142 |
| | | | | GIP-1/1-65 | 54 | H-P23 | 142 |
| | | | | GIP-1/1-100 | 54 | H-P23-C | 142 |
| | | | | GIP-1/1-150 | 54 | H-P33 | 142 |
| | | | | GIP-1/1-200 | 54 | H-P33-C | 142 |
| | | | | GIP-1/2-65 | 54 | | |
| | | | | GIP-1/2-100 | 54 | I | |
| | | | | GIP-1/2-150 | 54 | IT-5-MD | 120 |
| | | | | GIP-1/2-200 | 54 | IT-5-MDV | 120 |
| | | | | GIP-2/1-20 | 54 | IT-6-ECO | 119 |
| | | | | GIP-2/1-40 | 54 | IT-6- MAXI | 118 |
| | | | | GIP-2/1-65 | 54 | IT-6-MD-ECO | 119 |
| | | | | GIS-325 | 54 | IT-7-MD | 120 |
| | | | | GIS-530 | 54 | IT-8 | 119 |
| | | | | GIT-1/1 | 54 | IT-8-MD | 119 |
| | | | | GIT-1/2 | 54 | IT-9-MD | 120 |
| | | | | GIT-1/3 | 54 | IT-103 | 193 |
| | | | | GIT-1/4 | 54 | IT- 103-1F | 118 |
| | | | | GIT-1/6 | 54 | IT-103-E | 118 |
| | | | | GIT-1/9 | 54 | IT-105 | 193 |
| | | | | GIT-2/3 | 54 | IT-105- | 193 |
| | | | | GITH-1/1 | 54 | IT-105-V | 193 |
| | | | | GITH-1/2 | 54 | IT-106 | 193 |
| | | | | GITH-1/3 | 54 | IT-106-4 | 118 |
| | | | | GITH-1/4 | 54 | IT-106-E | 118 |
| | | | | GITH-1/6 | 54 | IT-107 | 193 |
| | | | | GITH-2/3 | 54 | IT-109 | 193 |
| | | | | GP-1/1-65 | 50 | IT-110 | 193 |
| | | | | GP-1/1-100 | 50 | IT-120 | 118 |
| | | | | GP-1/1-150 | 50 | IT-120-B | 118 |
| | | | | GP-1/1-200 | 50 | IT-120-V | 118 |
| | | | | GP-1/2-65 | 50 | IT-121 | 118 |
| | | | | GP-1/2-100 | 50 | ITR-125 | 121 |
| | | | | GP-1/2-150 | 50 | | |
| | | | | GP-1/2-200 | 50 | K | |
| | | | | GP-1/3-65 | 50 | K3M1P1 | 187 |
| | | | | GP-1/3-100 | 50 | K3M1P2 | 187 |
| | | | | GP-1/3-150 | 50 | K3M1P3 | 187 |
| | | | | GP-1/3-200 | 50 | K3M1P4 | 187 |
| | | | | GP-1/4-65 | 50 | K3M1P5 | 187 |
| | | | | | | K3M2P1 | 187 |
| | | | | | | K3M2P2 | 187 |

| | | | | | | | |
|----------|-----|----------|-----|--------------|-----|----------------|-----|
| K3M2P3 | 187 | K-205-5 | 178 | LM-5 | 105 | MP-32 MEC-T | 69 |
| K3M2P4 | 187 | K-206 | 178 | LM-10 | 105 | MP-32RE-T | 70 |
| K3M2P5 | 187 | K-206-5 | 178 | LM-10-P | 105 | MPP-10 | 82 |
| K3M3P1 | 187 | KBV-100 | 184 | LM-11 | 106 | MPQ-02 | 77 |
| K3M3P2 | 187 | KBV-150 | 184 | LM-21 | 107 | MPQ-MOZ-15 | 76 |
| K3M3P3 | 187 | KBV-200 | 184 | LM-21-1 | 107 | MPQ-MOZZARELLA | 76 |
| K3M3P4 | 187 | KD4M1P1 | 190 | LM-22 | 107 | MPQV-5-M | 78 |
| K3M3P5 | 187 | KD4M1P2 | 190 | LM-23 | 107 | MPQV-5-T | 78 |
| K3M4P1 | 187 | KD4M2P1 | 190 | LM-23-1 | 107 | MR-1 | 87 |
| K3M4P2 | 187 | KD4M2P2 | 190 | LM-23-2 | 107 | MR-1-ECO | 87 |
| K3M4P3 | 187 | KD4M3P1 | 190 | LM-23-3 | 107 | MR-2 | 88 |
| K3M4P4 | 187 | KD4M3P2 | 190 | LM-24 | 107 | MR-3 | 88 |
| K3M4P5 | 187 | KD4M4P1 | 190 | LM-25 | 108 | MR-4 | 86 |
| K3M5P1 | 187 | KD4M4P2 | 190 | LM-26 | 108 | MR-4-500 | 86 |
| K3M5P2 | 187 | KD4M5P1 | 190 | LM-27 | 108 | MR-4-500-ECO | 86 |
| K3M5P3 | 187 | KD4M5P2 | 190 | LMP-4 | 105 | MR-4-600 | 86 |
| K3M5P4 | 187 | KD4M6P1 | 190 | LMP-5 | 105 | MR-4-ECO | 86 |
| K3M5P5 | 187 | KD4M6P2 | 190 | M | | MR-5 | 89 |
| K3M6P1 | 187 | KL-25 | 183 | MC-3 | 80 | MR-6 | 89 |
| K3M6P2 | 187 | KL-50 | 183 | MC-5 | 81 | MR-7 | 89 |
| K3M6P3 | 187 | KL-55 | 183 | MC-8 | 81 | MR-8 | 89 |
| K3M6P4 | 187 | KL-100 | 183 | MC-CD-3 | 80 | MR-10 | 89 |
| K3M6P5 | 187 | KM-104 | 179 | MC-CD-5 | 80 | MR-10-1 | 89 |
| K4M1P1 | 189 | KM-104-5 | 179 | MC-CL-3 | 80 | MR-11 | 89 |
| K4M1P2 | 189 | KM-105 | 179 | MC-CL-5 | 80 | MR-12 | 89 |
| K4M1P3 | 189 | KM-105-5 | 179 | MC-CP-3 | 80 | MR-13 | 89 |
| K4M1P4 | 189 | KM-106 | 179 | MC-CP-5 | 80 | MR-14 | 89 |
| K4M1P5 | 189 | KM-106-5 | 179 | MC-E300 | 75 | MR-20 | 88 |
| K4M2P1 | 189 | KM-124 | 179 | MC-E350 | 75 | MR-30 | 88 |
| K4M2P2 | 189 | KM-124-S | 179 | MC-M350 | 75 | MR-40 | 88 |
| K4M2P3 | 189 | KM-125 | 179 | ME-L5 | 135 | MR-45 | 88 |
| K4M2P4 | 189 | KM-125-5 | 179 | ME-L7 | 135 | MR-46 | 88 |
| K4M2P5 | 189 | KM-126 | 179 | ME-L8 | 135 | MR-47 | 88 |
| K4M3P1 | 189 | KM-126-5 | 179 | ME-L8V | 135 | MR-49 | 88 |
| K4M3P2 | 189 | KM-154 | 179 | ME-L14 | 135 | MR-50 | 88 |
| K4M3P3 | 189 | KM-154-5 | 179 | MH-1 | 133 | MR-60 | 88 |
| K4M3P4 | 189 | KM-155 | 179 | MH-1-R | 133 | MR-80 | 88 |
| K4M3P5 | 189 | KM-155-5 | 179 | MH-2 | 134 | MR-90 | 88 |
| K4M4P1 | 189 | KM-156 | 179 | MH-3 | 134 | MR-103-I | 153 |
| K4M4P2 | 189 | KM-156-5 | 179 | MH-4 | 134 | MR-104-I | 153 |
| K4M4P3 | 189 | KM-204 | 179 | MH-5 | 134 | MR-105-I | 153 |
| K4M4P4 | 189 | KM-204-5 | 179 | MH-6 | 133 | MR-115-I | 153 |
| K4M4P5 | 189 | KM-205 | 179 | MH-6-1 | 194 | MR-119-I | 153 |
| K4M5P1 | 189 | KM-205-5 | 179 | MH-7 | 134 | MR-201 | 192 |
| K4M5P2 | 189 | KM-206 | 179 | MH-7-1 | 194 | MR-201-ECO | 192 |
| K4M5P3 | 189 | KM-206-5 | 179 | MH-8 | 134 | MR-202 | 192 |
| K4M5P4 | 189 | KP-104 | 181 | MH-8-1 | 194 | MR-202-ECO | 192 |
| K4M5P5 | 189 | KP-105 | 181 | MH-9 | 134 | MR-203 | 192 |
| K4M6P1 | 189 | KP-106 | 181 | MH-9-1 | 194 | MR-203-ECO | 192 |
| K4M6P2 | 189 | KP-124 | 181 | MH-10 | 132 | MR-204 | 192 |
| K4M6P3 | 189 | KP-125 | 181 | MH-13 | 132 | MR-205 | 192 |
| K4M6P4 | 189 | KP-126 | 181 | MH-15 | 132 | MR-206 | 192 |
| K4M6P5 | 189 | KP-154 | 181 | MH-20 | 133 | MR-206-ECO | 192 |
| *K-10 | 178 | KP-155 | 181 | MH-21 | 133 | MR-207 | 192 |
| ***K-15 | 178 | KP-156 | 181 | MH-22 | 133 | MR-208 | 192 |
| **K-15-P | 178 | KP-204 | 181 | MH-23 | 133 | MR-209 | 192 |
| K-104 | 178 | KP-205 | 181 | MH-25 | 133 | MR-210 | 192 |
| K-104-5 | 178 | KP-206 | 181 | MH-101 | 194 | MR-215 | 192 |
| K-105 | 178 | KP-250 | 182 | MH-102 | 194 | MSE-10 | 77 |
| K-105-5 | 178 | KP-300 | 182 | MH-103 | 194 | MT-152 | 95 |
| K-106 | 178 | KP-350 | 182 | MH-104 | 194 | MT-192 | 95 |
| K-106-5 | 178 | KP-400 | 182 | MH-105 | 194 | MTB-15 | 95 |
| K-124 | 178 | KP-500 | 182 | MH-107 | 194 | MTB-20 | 95 |
| K-124-5 | 178 | KTA-105 | 181 | MH-108 | 194 | MTB-27 | 95 |
| K-125 | 178 | KTA-106 | 181 | MH-109 | 194 | MTM-1/4 | 95 |
| K-125-5 | 178 | KTA-107 | 181 | MH-110 | 194 | MV-10 | 91 |
| K-126 | 178 | KTA-108 | 181 | MH-111 | 194 | MV-16 | 91 |
| K-126-5 | 178 | L | | MH-112 | 194 | MV-21 | 91 |
| K-154 | 178 | LM-1 | 105 | MP-8-M | 71 | MVS-330 | 92 |
| K-154-5 | 178 | LM-1-1 | 106 | MP-12MEC-M | 66 | MVS-430 | 91 |
| K-155 | 178 | LM-1-2 | 106 | MP-12MEC-T | 66 | N | |
| K-155-5 | 178 | LM-1-3 | 106 | MP-22 EURO-M | 67 | N-3 | 148 |
| K-156 | 178 | LM-2 | 105 | MP-22 EURO-T | 67 | N-9 | 148 |
| K-156-6 | 178 | LM-2-1 | 106 | MP22 MEC-M | 68 | N-20 | 148 |
| K-204 | 178 | LM-2-2 | 106 | MP-22 MEC-T | 68 | N-21 | 148 |
| K-204-5 | 178 | LM-2-P | 105 | MP-22RE-T | 70 | N-22 | 148 |
| K-205 | 178 | LM-4 | 105 | MP-32 MEC-M | 69 | N-30 | 148 |

P-V

| | |
|----------------|-----|
| N-31 | 148 |
| N-32 | 148 |
| O | |
| OZ-10G | 109 |
| P | |
| PB-1 | 98 |
| PB-1-M | 98 |
| PB-2 | 99 |
| PB-3 | 99 |
| PB-7 | 102 |
| PB-8 | 102 |
| PB-9 | 100 |
| PB-10 | 103 |
| PB-11 | 101 |
| PB-12 | 100 |
| PB-21 | 99 |
| PB-21N | 99 |
| PB-22 | 102 |
| PB-22N | 102 |
| PB-23 | 101 |
| PB-23N | 101 |
| PB-24 | 100 |
| PB-24N | 100 |
| PB-30 | 103 |
| PB-40 | 103 |
| PB-50 | 103 |
| PB-70 | 103 |
| PH-3 | 133 |
| PH-4 | 133 |
| PH-5 | 133 |
| PH-6 | 133 |
| PH-7 | 133 |
| PH-8 | 133 |
| PR-20 | 141 |
| PR-25 | 141 |
| PS-60 | 133 |
| PS-70 | 133 |
| PS-80 | 133 |
| R | |
| R-10-BE | 149 |
| R-10-BEP | 149 |
| R-10-G | 149 |
| R-10-GP | 149 |
| R-20 | 149 |
| R-21 | 149 |
| R-22 | 149 |
| R-30 | 150 |
| R-31 | 150 |
| R-40 | 43 |
| R-50 | 152 |
| R-75 | 152 |
| R-80 | 152 |
| R-100 | 152 |
| R-2020-AZ | 151 |
| R-2020-R | 151 |
| R-2020-V | 151 |
| R-2021 | 151 |
| R-2032-AZ | 151 |
| R-2032-R | 151 |
| R-2032-V | 151 |
| R-2054-AZ | 151 |
| R-2054-R | 151 |
| R-2054-V | 151 |
| RB-4-A | 146 |
| RB-4-AZ | 146 |
| RB-4-B | 146 |
| RB-4-R | 146 |
| RB-4-T | 146 |
| RB-4-V | 146 |
| RE-5-B | 147 |
| RE-5-N | 147 |
| RE-6-B | 147 |
| RE-6-N | 147 |
| RE-7 | 147 |
| RE-8 | 147 |
| Ref. BP-4013-N | 59 |

| | |
|----------------|-----|
| Ref. BP-6675-N | 59 |
| RT-5-A | 122 |
| RT-5-AZ | 122 |
| RT-5-B | 122 |
| RT-5-R | 122 |
| RT-5-V | 122 |
| RT-6-A | 122 |
| RT-6-AZ | 122 |
| RT-6-B | 122 |
| RT-6-R | 122 |
| RT-6-V | 122 |
| S | |
| SB-200 | 90 |
| SB-201 | 192 |
| SB-202 | 192 |
| SB-300 | 90 |
| SB-301 | 192 |
| SB-302 | 192 |
| SB-400 | 90 |
| SB-400-ECO | 90 |
| SB-401 | 192 |
| SB-402 | 192 |
| SB-451 | 192 |
| SB-500 | 90 |
| SB-500-ECO | 90 |
| SB-501 | 192 |
| SB-502 | 192 |
| SB-600 | 90 |
| SB-601 | 192 |
| SB-602 | 192 |
| SB-1000 | 90 |
| SB-1001 | 192 |
| SBPA-450 | 90 |
| SBPA-451 | 192 |
| SBPA-600 | 90 |
| SBPA-601 | 192 |
| SCA-1600 | 73 |
| SCA-1740 | 73 |
| SCA-1750 | 73 |
| SCA-1985 | 73 |
| SCA-2120 | 73 |
| SCA-2340 | 73 |
| SCA-2520 | 73 |
| SCA-2930 | 73 |
| SCO-1600 | 73 |
| SCO-1740 | 73 |
| SCO-1750 | 73 |
| SCO-1985 | 73 |
| SCO-2120 | 73 |
| SCO-2340 | 73 |
| SCO-2520 | 73 |
| SCO-2930 | 73 |
| SHU-1600 | 73 |
| SHU-1740 | 73 |
| SHU-1750 | 73 |
| SHU-1985 | 73 |
| SHU-2120 | 73 |
| SHU-2340 | 73 |
| SHU-2520 | 73 |
| SHU-2930 | 73 |
| SJ-4 | 136 |
| SJ-5-M | 137 |
| SJ-6-B | 137 |
| SJ-8 | 137 |
| SJ-9 | 136 |
| SJ-10 | 136 |
| SJ-16 | 137 |
| SJ-18 | 136 |
| SJ-600 | 137 |
| SJ-600-R | 137 |
| SM-5 | 98 |
| SM-6 | 98 |
| SPI-6 | 22 |
| T | |
| T-002 | 143 |
| T-003 | 143 |

| | |
|----------------|-----|
| T-005 | 143 |
| T-007 | 143 |
| T-008 | 143 |
| T-009 | 143 |
| T-012 | 143 |
| T-050 | 143 |
| T-360 | 141 |
| TA-002 | 143 |
| TC-180 | 165 |
| TC-200 | 165 |
| TC-220 | 165 |
| TC-240 | 165 |
| TC-280 | 165 |
| TF-200 | 165 |
| TF-225 | 165 |
| TM-430 | 165 |
| TM-500 | 165 |
| TP-210 | 165 |
| TP-230 | 165 |
| TP-250 | 165 |
| TT-265 | 165 |
| V | |
| V-A404015E | 8 |
| V-A404025E | 8 |
| V-A443215E | 8 |
| V-A444425E | 8 |
| V-A505025E | 8 |
| V-A604015E | 8 |
| V-A604025E | 8 |
| V-A705025E | 8 |
| V-A804025E | 8 |
| V-A806015E | 8 |
| V-A1005025E | 8 |
| V-BPGD | 11 |
| V-BPGDI | 11 |
| V-F404025PL | 15 |
| V-F454525PL | 15 |
| V-F505025PL | 15 |
| V-F604025PL | 15 |
| V-F705025PL | 15 |
| V-FA404020PL | 16 |
| V-FA454520PL | 16 |
| V-FA505020PL | 16 |
| V-FA604020PL | 16 |
| V-FA705020PL | 16 |
| V-FA1005020PL | 16 |
| V-FI2404020PL | 16 |
| V-FI2454520PL | 16 |
| V-FI2505020PL | 16 |
| V-FI2604020PL | 16 |
| V-FI2705020PL | 16 |
| V-FI21005020PL | 16 |
| V-FS454520PL | 16 |
| V-FS604020PL | 16 |
| V-FS705020PL | 16 |
| V-G37245E | 10 |
| V-G443210E | 10 |
| V-G443215E | 10 |
| V-G443220E | 10 |
| V-G443225E | 10 |
| V-G604015E | 10 |
| V-G604025E | 10 |
| V-G705025E | 10 |
| V-G804025E | 10 |
| V-G806015E | 10 |
| V-G1005025E | 10 |
| V-GOMA | 7 |
| V-GUIA-40 | 7 |
| V-GUÍA 50 I | 7 |
| V-GUÍA 50 L | 7 |
| V-H355 | 15 |
| V-H359 | 15 |
| V-H405 | 15 |
| V-H409 | 15 |
| V-H3514 | 15 |
| V-H4014 | 15 |
| V-H25191.5 | 13 |

| | |
|------------|----|
| V-H25192 | 13 |
| V-H25193 | 13 |
| V-H25194 | 14 |
| V-H25195 | 14 |
| V-H30201.5 | 13 |
| V-H30202 | 13 |
| V-H30203 | 13 |
| V-H30204 | 14 |
| V-H30205 | 14 |
| V-H33191.5 | 13 |
| V-H33192 | 13 |
| V-H33193 | 13 |
| V-H33194 | 14 |
| V-H33195 | 14 |
| V-H33331.5 | 13 |
| V-H33332 | 13 |
| V-H33333 | 13 |
| V-H33334 | 14 |
| V-H33335 | 14 |
| V-H40201.5 | 13 |
| V-H40202 | 13 |
| V-H40203 | 13 |
| V-H40204 | 14 |
| V-H40205 | 14 |
| V-H40251.5 | 13 |
| V-H40252 | 13 |
| V-H40253 | 13 |
| V-H40254 | 14 |
| V-H40255 | 14 |
| V-H40301.5 | 13 |
| V-H40302 | 13 |
| V-H40303 | 13 |
| V-H40304 | 14 |
| V-H40305 | 14 |
| V-H40331.5 | 13 |
| V-H40332 | 13 |
| V-H40333 | 13 |
| V-H40334 | 14 |
| V-H40335 | 14 |
| V-H40339 | 15 |
| V-H40401.5 | 13 |
| V-H40402 | 13 |
| V-H40403 | 13 |
| V-H40404 | 14 |
| V-H40405 | 14 |
| V-H40409 | 15 |
| V-H45455 | 14 |
| V-H45459 | 15 |
| V-H50251.5 | 13 |
| V-H50252 | 13 |
| V-H50253 | 13 |
| V-H50254 | 14 |
| V-H50255 | 14 |
| V-H50301.5 | 13 |
| V-H50302 | 13 |
| V-H50303 | 13 |
| V-H50304 | 14 |
| V-H50305 | 14 |
| V-H50331.5 | 13 |
| V-H50332 | 13 |
| V-H50333 | 13 |
| V-H50334 | 14 |
| V-H50335 | 14 |
| V-H50339 | 15 |
| V-H50401.5 | 13 |
| V-H50402 | 13 |
| V-H50403 | 13 |
| V-H50404 | 14 |
| V-H50405 | 14 |
| V-H50501.5 | 13 |
| V-H50502 | 13 |
| V-H50503 | 13 |
| V-h50504 | 14 |
| V-H50505 | 14 |
| V-H50509 | 15 |
| V-H60251.5 | 13 |
| V-H60252 | 13 |

| | | | | | | | |
|--------------|----|--------------|----|------------|-----|-----------|-----|
| V-H60253 | 13 | V-HG40302V | 22 | V-S444425E | 9 | Y-40302 | 12 |
| V-H60254 | 14 | V-HRP-40302S | 20 | V-S604025E | 9 | Y-40303 | 12 |
| V-H60255 | 14 | V-I2404025E | 9 | V-S705025E | 9 | Y-40402 | 12 |
| V-H60301.5 | 13 | V-I2444425E | 9 | V-SP2B | 22 | Y-40403 | 12 |
| V-H60302 | 13 | V-I2505025E | 9 | V-SP2M | 22 | Y-40405 | 12 |
| V-H60303 | 13 | V-I2604025E | 9 | V-SP2R | 22 | Y-45455 | 12 |
| V-H60304 | 14 | V-I2705025E | 9 | V-T30282 | 12 | Y-50302 | 12 |
| V-H60305 | 14 | V-I2804025E | 9 | V-T35252 | 12 | Y-50303 | 12 |
| V-H60331.5 | 13 | V-I21005025E | 9 | V-T50255 | 12 | Y-50502 | 12 |
| V-H60332 | 13 | V-K40405 | 18 | V-T50355 | 12 | Y-50503 | 12 |
| V-H60333 | 13 | V-K40409 | 18 | V-T50405 | 12 | Y-50505 | 12 |
| V-H60334 | 14 | V-K45455 | 18 | V-T60505 | 12 | Y-60402 | 12 |
| V-H60335 | 14 | V-K45459 | 18 | V-TOPE | 7 | Y-60403 | 12 |
| V-H60401.5 | 13 | V-K50505 | 18 | V-TP30202 | 22 | Y-60405 | 12 |
| V-H60402 | 13 | V-K50509 | 18 | V-TP35252 | 22 | Y-70505 | 12 |
| V-H60403 | 13 | V-K60405 | 18 | | | | |
| V-H60404 | 14 | V-K60409 | 18 | W | | Z | |
| V-H60405 | 14 | V-K70505 | 18 | W-25-A | 113 | Z-10 | 194 |
| V-H60409 | 15 | V-K70509 | 18 | W-25-AZ | 113 | Z-11 | 194 |
| V-H65455 | 14 | V-K540405 | 18 | W-25-B | 113 | Z-11-U | 194 |
| V-H70505 | 14 | V-K540409 | 18 | W-25-M | 113 | Z-15 | 194 |
| V-H75251.5 | 13 | V-K545455 | 18 | W-25-V | 113 | Z-20 | 194 |
| V-H75252 | 13 | V-K545459 | 18 | W-40-A | 113 | Z-20-F | 194 |
| V-H75253 | 13 | V-K550505 | 18 | W-40-AZ | 113 | Z-21 | 194 |
| V-H75254 | 14 | V-K550509 | 18 | W-40-B | 113 | Z-40 | 194 |
| V-H75255 | 14 | V-K560405 | 18 | W-40-M | 113 | Z-151 | 123 |
| V-H75331.5 | 13 | V-K560409 | 18 | W-40-V | 113 | Z-420-MD | 123 |
| V-H75332 | 13 | V-K570505 | 18 | W-60 | 112 | Z-430-MD | 123 |
| V-H75333 | 13 | V-K570509 | 18 | W-80 | 112 | Z-440-MD | 123 |
| V-H75334 | 14 | V-L240405 | 17 | W-81 | 112 | Z-600 | 124 |
| V-H75335 | 14 | V-L240409 | 17 | W-120 | 112 | Z-700 | 124 |
| V-H80405 | 14 | V-L245455 | 17 | W-240 | 112 | Z-700-ECO | 124 |
| V-H90455 | 14 | V-L245459 | 17 | WI-35 | 114 | Z-740 | 124 |
| V-H100251.5 | 13 | V-L250505 | 17 | WI-60 | 115 | Z-911 | 125 |
| V-H100252 | 13 | V-L250509 | 17 | WI-70 | 114 | Z-911-A | 125 |
| V-H100253 | 13 | V-L260405 | 17 | WI-75 | 114 | Z-911-N | 125 |
| V-H100254 | 14 | V-L260409 | 17 | WI-90 | 115 | Z-918 | 125 |
| V-H100255 | 14 | V-L270505 | 17 | WI-110 | 115 | Z-918-A | 125 |
| V-H100331.5 | 13 | V-L270509 | 17 | | | Z-918-N | 125 |
| V-H100332 | 13 | V-MI5050 | 19 | X | | Z-931 | 127 |
| V-H100333 | 13 | V-MI7050 | 19 | X-0024 | 39 | Z-931-A | 127 |
| V-H100334 | 14 | V-MI10060C | 19 | X-0100 | 39 | Z-940 | 127 |
| V-H100335 | 14 | V-MI10060S | 19 | X-0101 | 39 | Z-940-A | 127 |
| V-H100505 | 14 | V-MI10070C | 19 | X-0102 | 39 | Z-950 | 126 |
| V-H150251.5 | 13 | V-MI10070S | 19 | X-0200 | 40 | Z-950-A | 126 |
| V-H150252 | 13 | V-MI15060C | 19 | X-0201 | 40 | Z-960 | 126 |
| V-H150253 | 13 | V-MI15060S | 19 | X-0202 | 40 | Z-960-A | 126 |
| V-H150254 | 14 | V-MI15070C | 19 | X-0203 | 40 | ZL-7 | 194 |
| V-H150255 | 14 | V-MI15070S | 19 | X-0204 | 40 | ZT-4.5 | 194 |
| V-H150331.5 | 13 | V-MI20060C | 19 | X-0210 | 40 | ZT-6.5 | 194 |
| V-H150332 | 13 | V-MI20060S | 19 | X-0724 | 39 | ZT-7 | 194 |
| V-H150333 | 13 | V-MI20070C | 19 | X-2500 | 38 | ZT-10 | 194 |
| V-H150334 | 14 | V-MI20070S | 19 | X-2503 | 38 | | |
| V-H150335 | 14 | V-O3510E | 10 | X-2504 | 38 | | |
| V-H200251.5 | 13 | V-O3515E | 10 | X-2505 | 38 | | |
| V-H200252 | 13 | V-O3520E | 10 | X-2509 | 38 | | |
| V-H200253 | 13 | V-O6090 | 9 | X-2514 | 38 | | |
| V-H200254 | 14 | V-O404015E | 10 | X-2515 | 41 | | |
| V-H200255 | 14 | V-O404025E | 10 | X-2530 | 41 | | |
| V-H200331.5 | 13 | V-O444410E | 10 | X-2800 | 38 | | |
| V-H200332 | 13 | V-O444420E | 10 | X-2801 | 38 | | |
| V-H200333 | 13 | V-O444425E | 10 | X-2804 | 38 | | |
| V-H200334 | 14 | V-O505025E | 10 | X-2900 | 41 | | |
| V-H200335 | 14 | V-P40404 | 17 | X-2901 | 41 | | |
| V-H403314 | 15 | V-P45454 | 17 | X-2902 | 41 | | |
| V-H503314 | 15 | V-P50504 | 17 | X-2903 | 41 | | |
| V-H2001001.5 | 13 | V-P60404 | 17 | X-2904 | 41 | | |
| V-H2001002 | 13 | V-P70504 | 17 | X-2905 | 41 | | |
| V-H2001003 | 13 | V-PF | 7 | X-2906 | 41 | | |
| V-H2001004 | 14 | V-PORACE-40 | 6 | X-2907 | 41 | | |
| V-H2001005 | 14 | V-PORACE-44 | 6 | X-2909 | 41 | | |
| V-HAGU5 | 15 | V-PORACE-50 | 6 | X-6886 | 40 | | |
| V-HAGU9 | 15 | V-PORMAD | 6 | X-9005 | 40 | | |
| V-HAGU14 | 15 | V-PORPOLB | 6 | | | | |
| V-HC3320 | 15 | V-PORPOLR | 6 | Y | | | |
| V-HC5020 | 15 | V-PR | 7 | Y-30201 | 12 | | |
| V-HC10020 | 15 | V-S443225E | 9 | Y-30202 | 12 | | |
| | | | | Y-30203 | 12 | | |
| | | | | Y-40301 | 12 | | |

CONDICIONES GENERALES DE VENTA

RECLAMACIONES

- La mercancía viajará por cuenta y riesgo del comprador debiendo notificar cualquier reclamación antes de 24 horas y haciendolo constar ante la empresa de transportes.
- Rogamos hacer constar siempre en la entrega del transportista **“SALVO EXAMEN”** si no se puede revisar la mercancía en ese momento.

DEVOLUCIONES

- Devoluciones de mercancía, siempre por nuestra agencia habitual. **NO SE ACEPTARÁN DEVOLUCIONES** sin antes comunicarlo a **J-2 IMPORTACIONES Y DISTRIBUCIONES** por teléfono y e-mail.

PEDIDOS MÍNIMOS

- Pedidos mínimos 100 euros netos. Inferiores se cargaran 10 euros gastos de administración.

CONFLICTOS

- En caso de litigio se resolverán en el juzgado correspondiente a la plaza del vendedor con renuncia de cualquier otro fuero.

2024



J2 IMPORTACIONES Y DISTRIBUCIONES

Turó de la Trinitat, 4 - 6
08033 Barcelona - España
93 311 54 20 | 93 311 59 50
j-2@j-2.es
pedidos@j-2.es

Pol. Industrial Can Milans
C/ Can Milans, 47
08110 MONTACADA I REIXAC
Barcelona - España

www.j-2.es